



NON-INTERVENTIONAL (NI) STUDY CONCEPT PROTOCOL

Title	Active Safety Surveillance of the Pfizer-BioNTech COVID-19 Vaccine in the United States Department of Defense Population Following Emergency Use Authorization
Protocol number	C4591011
Protocol version identifier	Final Version 1.0
Date of last version of protocol	29 January 2021
EU Post Authorization Study (PAS) register number	To be registered before the start of data collection
Active substance	COVID-19 mRNA Vaccine is single-stranded, 5'-capped messenger RNA (mRNA) produced using a cell-free in vitro transcription from the corresponding DNA templates, encoding the viral spike (S) protein of SARS-CoV-2.
Medicinal product	Pfizer-BioNTech COVID-19 Vaccine (BNT162b2)
Research question and objectives	<p>Research question: what are the incidence rates of safety events of interest (based on adverse events of special interest [AESI]) among individuals vaccinated with the Pfizer-BioNTech COVID-19 vaccine within the United States Department of Defense (DoD) Military Health System (MHS) overall and in sub-cohorts of interest, as compared to expected rates of those events?</p> <p><i>Primary study objectives:</i></p> <ul style="list-style-type: none"> • To assess whether individuals in the DoD MHS experience increased risk of safety events of interest following receipt of the Pfizer-BioNTech COVID-19 vaccine; • To assess whether sub-cohorts of interest (i.e., pregnant women,

090177e1962518d5\Approved\Approved On: 29-Jan-2021 20:00 (GMT)

090177e1962518d5\Approved\Approved On: 29-Jan-2021 20:00 (GMT)

	<p>immunocompromised, elderly, individuals with specific comorbidities, individuals receiving only one dose of the Pfizer-BioNTech COVID-19 vaccine, and individuals with prior SARS-CoV-2 infection) in the DoD MHS experience increased risk of safety events of interest following receipt of the Pfizer-BioNTech COVID-19 vaccine.</p> <p><i>Secondary study objective:</i></p> <ul style="list-style-type: none"> To characterize utilization patterns of the Pfizer-BioNTech COVID-19 vaccine among individuals within the DoD MHS, including estimating the proportion of individuals receiving vaccine, 2-dose vaccine completion rate, and distribution of time gaps between the first and second dose, demographics and health histories of recipients, overall and among the sub-cohorts of interest.
<p>Authors</p>	<p>Renu Garg, PhD, MPH Safety Surveillance Research Scientist Pfizer, Inc. New York, NY</p> <p>Mei Sheng Duh, ScD, MPH Managing Principal and Chief Epidemiologist Analysis Group, Inc. Boston, MA</p>

This document contains confidential information belonging to Pfizer. Except as otherwise agreed to in writing, by accepting or reviewing this document, you agree to hold this information in confidence and not copy or disclose it to others (except where required by applicable law) or use it for unauthorized purposes. In the event of any actual or suspected breach of this obligation, Pfizer must be promptly notified.

1. TABLE OF CONTENTS

1. TABLE OF CONTENTS.....	3
2. LIST OF ABBREVIATIONS.....	5
3. RESPONSIBLE PARTIES.....	8
4. ABSTRACT.....	9
5. AMENDMENTS AND UPDATES.....	22
6. MILESTONES.....	23
7. RATIONALE AND BACKGROUND.....	24
8. RESEARCH QUESTION AND OBJECTIVES	25
9. RESEARCH METHODS	26
9.1. Study Design	26
9.1.1. Self-Controlled Risk Interval (SCRI) Design.....	26
9.1.2. Active Comparator Design	29
9.1.3. Contemporary Unvaccinated Control Design.....	30
9.1.4. Study Period.....	31
9.2. Setting.....	31
9.2.1. Inclusion Criteria	31
9.2.2. Exclusion criteria.....	31
9.2.3. Subgroups	31
9.3. Variables.....	32
9.3.1. Exposure of Interest.....	32
9.3.1.1. Pfizer-BioNTech COVID-19 Vaccine Groups of Interest	33
9.3.2. Baseline Characteristics.....	33
9.3.3. Outcomes	35
9.4. Data Source	42
9.5. Study Size.....	43
9.5.1. Power	43
9.6. Data Management	45
9.6.1. Case report forms (CRFs)/Electronic data record	45
9.6.2. Record retention.....	45
9.7. Data Analysis	46
9.7.1. Identification of Contemporary Unvaccinated Controls.....	46

090177e1962518d5\Approved\Approved On: 29-Jan-2021 20:00 (GMT)

9.7.2. Baseline Characteristics.....	47
9.7.3. Vaccine Utilization Patterns	47
9.7.4. Safety Signal Analyses	47
9.7.4.1. Signal Detection	48
9.7.4.2. Signal Evaluation	52
9.7.4.3. Signal Verification	54
9.7.5. Seasonality-Adjusted Cases-Centered Method.....	54
9.7.6. End-of-Season and End-of-Surveillance Analyses.....	55
9.7.7. Subgroup Analysis.....	56
9.7.8. Incidence Rates and Time to Safety Event of Interest Analysis.....	56
9.8. Quality Control.....	57
9.9. Strengths and Limitations of the Research Methods.....	57
9.10. Other Aspects	58
10. PROTECTION OF HUMAN SUBJECTS	58
10.1. Patient Information.....	58
10.2. Patient Consent.....	59
10.3. Institutional Review board (IRB)/Independent Ethics Committee (IEC)	59
10.4. Ethical Conduct of the Study	59
11. MANAGEMENT AND REPORTING OF ADVERSE EVENTS/ADVERSE REACTIONS	59
12. PLANS FOR DISSEMINATING AND COMMUNICATING STUDY RESULTS.....	61
13. REFERENCES	62
14. LIST OF TABLES	66
15. LIST OF FIGURES	66
16. ANNEX 1. LIST OF STAND-ALONE DOCUMENTS.....	66
17. ANNEX 2. ENCEPP CHECKLIST FOR STUDY PROTOCOLS	66
18. ANNEX 3. ADDITIONAL INFORMATION.....	66

090177e1962518d5\Approved\Approved On: 29-Jan-2021 20:00 (GMT)

2. LIST OF ABBREVIATIONS

Abbreviation	Definition
ACIP	Advisory Committee on Immunization Practices
ADEM	Acute disseminated encephalomyelitis
AE	Adverse event
AEM	Adverse event monitoring
AESI	Adverse events of special interest
AIDS	Acquired immunodeficiency syndrome
AMI	Acute myocardial infarction
BMI	Body mass index
CAD	Coronary artery disease
CI	Confidence Interval
CCI	Charlson comorbidity index
CDC	Centers for Disease Control and Prevention
CIDP	Chronic inflammatory demyelinating polyneuropathy
CMA	Conditional Marketing Authorization
COPD	Chronic obstructive pulmonary disease
COVID-19	Coronavirus Disease 2019
CPT	Current Procedural Terminology
CRFs	Case report forms
DIC	Disseminated intravascular coagulation
DoD	Department of Defense
DVT	Deep vein thrombosis
TDap	Diphtheria, tetanus and (acellular) pertussis
Td	Diphtheria and tetanus
ED	Emergency department
EMA	European Medicines Agency
EMR	Electronic medical records
EU	European Union
EUA	Emergency Use Authorization
EU PAS	European Union Post-Authorization Safety
FDA	Food and Drug Administration
GBS	Guillain-Barré syndrome
GEP	Good Epidemiological Practice
GPP	Good Pharmacoepidemiology Practices
H ₀	Null hypothesis
H _a	Alternative hypothesis
HBV	Hepatitis B virus
HCPCS	Healthcare Common Procedure Coding System
HCV	Hepatitis C virus
HIV	Human immunodeficiency virus
HPV	Human papillomavirus
HRTx	Health ResearchTx

090177e1962518d5\Approved\Approved On: 29-Jan-2021 20:00 (GMT)

Abbreviation	Definition
ICD-10-CM	International Classification of Diseases, Tenth Revision, Clinical Modification
ICD-10-PCS	International Classification of Diseases, Tenth Revision, Procedure Coding System
IDN	Integrated delivery network
IEA	International Epidemiological Association
IEC	Independent Ethics Committee
IQR	Interquartile range
IRB	Institutional Review Board
ITP	Immune thrombocytopenia
KD	Kawasaki disease
LLR	Log-likelihood ratio
MaxSPRT	Maximized sequential probability ratio test
MenACWY	Meningococcal conjugate
MenB	Serogroup B meningococcal
MDR	MHS Data Repository
MHS	Military Health System
MIS-A	Multisystem inflammatory syndrome in adults
mRNA	Messenger RiboNucleic Acid
MS	Multiple sclerosis
NDC	National Drug Code
NIS	Non-interventional study
ON	Optic neuritis
PASS	Post-Authorization Safety Study
PB	Privacy board
PDTS	Pharmacy data transaction system
PRISM	Post-Licensure Rapid Immunization Safety Monitoring
RCA	Rapid cycle analysis
RR	Relative risk
SAP	Statistical analysis plan
SARS-CoV-2	Severe acute respiratory syndrome coronavirus 2
SAS	SAS Institute
SCRI	Self-controlled risk interval
SD	Standard deviation
SPEAC	Safety Platform for Emergency vACcines
TM	Transverse myelitis
TRICARE	US Department of Defense purchased care
UK	United Kingdom
US	United States
VAED	Vaccine-associated enhanced disease
VAERS	Vaccine Adverse Event Reporting System
VSD	Vaccine Safety Datalink

090177e1962518d5\Approved\Approved On: 29-Jan-2021 20:00 (GMT)

Abbreviation	Definition
VTE	Venous thromboembolism
WHO	World Health Organization
YRR	Your Reporting Responsibilities

3. RESPONSIBLE PARTIES

Principal Investigators of the Protocol

Name, degree(s)	Job Title	Affiliation	Address
Renu Garg, PhD, MPH	Safety Surveillance Research Scientist	Pfizer, Inc.	235 East 42nd Street, New York, NY 10017
Mei Sheng Duh, ScD, MPH	Managing Principal and Chief Epidemiologist	Analysis Group, Inc.	111 Huntington Ave 14 th Floor Boston, MA 02199
	Visiting Scientist, Department of Biostatistics	Harvard T. H. Chan School of Public Health	677 Huntington Ave Boston, MA 02115
Maral DerSarkissian, PhD	Vice President and Senior Epidemiologist	Analysis Group, Inc.	333 South Hope Street 27th Floor Los Angeles, CA 90071
	Adjunct Assistant Professor	Fielding School of Public Health, University of California, Los Angeles	650 Charles E Young Drive South Los Angeles, CA 90095

090177e1962518d5\Approved\Approved On: 29-Jan-2021 20:00 (GMT)

4. ABSTRACT

Title: Active Safety Surveillance of the Pfizer-BioNTech COVID-19 Vaccine in the United States Department of Defense Population Following Emergency Use Authorization

Protocol Version: 1.0; Date of Protocol: 29 January 2021

Authors: Renu Garg, PhD, MPH, Pfizer, Inc.; Mei Sheng Duh, ScD, MPH, Analysis Group, Inc.

Rationale and background:

In March 2020, the World Health Organization (WHO) declared a global pandemic for the coronavirus disease 2019 (COVID-19) due to the severe acute respiratory syndrome coronavirus 2 (SARS-CoV-2), which was first identified by public health officials in China in December 2019.¹ The COVID-19 pandemic presents an unprecedented public health crisis. As of January 7, 2021, over 21.4 million COVID-19 cases and 364,000 deaths have been reported in the United States (US) alone.²

Pfizer and BioNTech have partnered to develop a novel messenger RiboNucleic Acid (mRNA) vaccine against SARS-CoV-2 for the prevention of COVID-19 (Candidate BNT162b2). Pfizer is conducting a Phase 1/2/3, randomized, placebo-controlled, observer-blind, dose-finding, vaccine candidate-selection, and efficacy study among healthy individuals (NCT04368728). The Food and Drug Administration (FDA) reviewed the available safety data from 37,586 participants 16 years of age and older and did not identify any specific safety concerns. In addition, the analysis of available efficacy data from 36,523 participants 12 years of age and older without evidence of prior SARS-CoV-2 infection at least 7 days after receiving the second dose demonstrated 95% efficacy of the vaccine in the prevention of COVID-19 (as confirmed by 8 vs. 162 COVID-19 cases in the vaccine and placebo groups, respectively).^{3,4} Based on these safety and efficacy data, as well as a review of manufacturing information regarding product quality and consistency, the FDA determined that the known and potential benefits of the vaccine outweighed the known and potential risks for the prevention of COVID-19 in individuals 16 years of age and older.⁴ Therefore on December 11, 2020, the Pfizer-BioNTech COVID-19 vaccine was granted an Emergency Use Authorization (EUA) by the FDA to prevent COVID-19 in individuals 16 years of age and older.⁵

With respect to geographic regions other than the US, on December 2, 2020, the United Kingdom (UK) was the first country in the world to grant temporary authorization for emergency use of the Pfizer-BioNTech COVID-19 vaccine.⁶ On December 21, 2020, the European Medicines Agency (EMA) granted the Pfizer-BioNTech COVID-19 vaccine a conditional marketing authorization (CMA) for use among individuals 16 years of age and older throughout all of the European Union's (EU) 27 member states.⁷

As required by the EUA, post-authorization observational studies using real-world data are needed in order to assess the association between Pfizer-BioNTech COVID-19 vaccine and pre-determined safety events of interest (including deaths, hospitalizations, and severe

COVID-19) among individuals administered the vaccine in both the population at large and in populations of interest (e.g., pregnant women, immunocompromised individuals, elderly, and those with specific comorbidities).⁴ Pfizer, in collaboration with Health ResearchTx (HRTx) and Analysis Group, herein proposes post-EUA active surveillance of safety events of interest in the Department of Defense (DoD) population based on the Priority List of Adverse Events of Special Interest from the Brighton Collaboration's Safety Platform for Emergency vACCines (SPEAC) Project, and the FDA and the Centers for Disease Control and Prevention's (CDC) Advisory Committee on Immunization Practices (ACIP) enhanced safety monitoring recommendation. As part of phased allocation of COVID-19 vaccinations, all healthcare providers, emergency services, and public safety personnel within the DoD population will qualify to receive the COVID-19 vaccine.⁸ This safety surveillance study will identify and evaluate rapid, near real-time potential safety signals associated with the Pfizer-BioNTech COVID-19 vaccine in the large-scale DoD Military Health System (MHS) healthcare database, which includes both administrative claims data and clinical data from electronic medical records (EMR). The observed safety event of interest rates will be compared to expected rates derived from self-controls, active comparators receiving seasonal influenza vaccination, and contemporary unvaccinated controls. Part of the methodologies used in this study are constructed based on approaches previously used by the Post-Licensure Rapid Immunization Safety Monitoring (PRISM) program for the H1N1 vaccine.⁹ This non-interventional study is designated as a Post-Authorization Safety Study (PASS) commitment to the US FDA and is a Category 3 commitment in the EU Risk Management Plan.

Research question and objectives:

Research question: what are the incidence rates of safety events of interest (based on adverse events of special interest AESI among individuals vaccinated with the Pfizer-BioNTech COVID-19 vaccine within the US DoD MHS overall and in sub-cohorts of interest, as compared to expected rates of those events?

Primary study objectives:

- To assess whether individuals in the DoD MHS experience increased risk of safety events of interest following receipt of the Pfizer-BioNTech COVID-19 vaccine;
- To assess whether sub-cohorts of interest (i.e., pregnant women, immunocompromised, elderly, individuals with specific comorbidities, individuals receiving only one dose of the Pfizer-BioNTech COVID-19 vaccine, and individuals with prior SARS-CoV-2 infection) in the DoD MHS experience increased risk of safety events of interest following receipt of the Pfizer-BioNTech COVID-19 vaccine.

Secondary study objective:

- To characterize utilization patterns of the Pfizer-BioNTech COVID-19 vaccine among individuals within the DoD MHS, including estimating the proportion of individuals receiving vaccine, 2-dose vaccine completion rate, and distribution of

time gaps between the first and second dose, demographics and health histories of recipients, overall and among the sub-cohorts of interest.

Study design: This post-EUA active safety surveillance program will employ a rapid-cycle, longitudinal, observational cohort study design to provide early real-world safety information.

- The self-controlled risk interval (SCRI) design will be used to sequentially monitor occurrence of safety events of interest while controlling for time-invariant confounders. The SCRI design uses data from cases (i.e., individuals who experience safety events of interest following vaccination) to compare the risk interval following vaccination to pre- or post-vaccination non-risk intervals (“pre-vaccination control interval” and “post-vaccination control interval”) in the same individual.
- Safety events of interest associated with Pfizer-BioNTech COVID-19 vaccinations will also be sequentially monitored and compared to two comparator populations:
 - (a) Recipients of influenza vaccine in the DoD MHS during 2014/2015 through 2018/2019 flu seasons, as an active comparator. Data in peri-COVID time periods from January 2020 to present are excluded because of pandemic-associated underutilization of health resources and underreporting of medical events.
 - (b) A sample of contemporary unvaccinated matched controls in the DoD MHS, as a general population comparator group, who will be identified during the same time period as individuals receiving the Pfizer-BioNTech COVID-19 vaccine to reflect the background rate of current safety events of interest. The contemporary unvaccinated controls will be randomly sampled to match the baseline demographic and clinical characteristics of individuals who receive the Pfizer-BioNTech COVID-19 vaccine (via both exact and propensity score matching, using a ratio of 1:N, but no more than 1:4 due to diminishing gains in efficiency) in order to ensure that the cohorts are comparable.

Population: The exposed population will be kept as broad as possible in order to capture safety events of interest that occur among all individuals receiving the Pfizer-BioNTech COVID-19 vaccine in the period from December 11, 2020 to present. Individuals will be included if they have a record of at least one dose of Pfizer-BioNTech COVID-19 vaccine in the period. Individuals who receive at least one dose of COVID-19 vaccine from a manufacturer other than Pfizer-BioNTech will be identified and reported, but they will be excluded from further analysis.

The influenza vaccine comparator cohort will be identified based on a record of at least one dose of seasonal influenza vaccine during prior flu seasons, from 2014/2015 through 2018/2019.

The contemporary unvaccinated control cohort will be randomly sampled from individuals in DoD MHS who did not receive any COVID-19 vaccine on or after December 11, 2020. They will be matched to individuals who received the Pfizer-BioNTech COVID-19 vaccine on baseline demographic and clinical characteristics via both exact and propensity score matching in the time period of December 11, 2020 onwards.

All individuals will be required to have at least 1 year of continuous enrollment (i.e., baseline period) prior to vaccination date (or matched index date for unvaccinated controls). Depending on the attrition rate, the length of the baseline period may be modified to 6 months.

Variables:

- Exposures: Administration of Pfizer-BioNTech COVID-19 vaccine post-EUA approval will be identified based on the following:
 - Current Procedural Terminology (CPT) code 91300 (Severe acute respiratory syndrome coronavirus 2 (SARS-CoV-2) (coronavirus disease [COVID-19]) vaccine, mRNA LNP, spike protein, preservative free, 30 mcg/0.3mL dosage, diluent reconstituted, for intramuscular use) and associated vaccine administration HCPCS codes corresponding to the first dose: 0001A (ADM SARS-CoV-2 30 mcg/0.3mL 1st), and the second dose: 0002A (ADM SARS-CoV-2 30 mcg/0.3mL 2nd);^{10,11} OR
 - 10 and 11-digit National Drug Codes (NDCs) 59267-1000-1 (corresponds to first dose), 59267-1000-01 (corresponds to second dose);¹⁰ OR
 - Immunization records that contain data on vaccine code descriptor, vaccine manufacturer (i.e., Pfizer), lot number, injection site, and date(s) of immunization;¹⁰

Relevant codes will be continuously reviewed and amended if new codes are added.

- Administration of the seasonal influenza vaccine during 2014/2015 through 2018/2019 flu seasons will be identified based on the following:
 - CPT codes
 - 90654 (Influenza virus vaccine, trivalent (IIV3), split virus, preservative-free, for intradermal use); OR
 - 90656 (Influenza virus vaccine, trivalent (IIV3), split virus, preservative free, 0.5 mL dosage, for intramuscular use); OR
 - 90658 (Influenza virus vaccine, trivalent (IIV3), split virus, 0.5 mL dosage, for intramuscular use); OR

- 10 and 11-digit NDCs; OR
- Immunization records that contain data on vaccine code descriptor, vaccine manufacturer, lot number, injection site, and date(s) of immunization.
- **Outcomes:** Safety events of interest for active surveillance (see [Table 1](#) and [Appendix Table 2](#)) are based on the Priority List of Adverse Events of Special Interest from the Brighton Collaboration’s Safety Platform for Emergency vACcines (SPEAC) Project, the FDA, and the Centers for Disease Control and Prevention’s (CDC) Advisory Committee on Immunization Practices (ACIP) enhanced safety monitoring recommendations.

The list of safety events of interest may be revised over the course of the study, and if unanticipated potential safety events of interest are identified during the course of surveillance, they will be added to the list and included in the analyses of interest. The risk and control intervals for each safety event of interest are based on biological plausibility and precedents in the literature (see [Table 1](#)). Outpatient (including emergency department) and/or inpatient settings will be used to identify safety events of interest, depending on the type of event. The specific encounter setting to be considered for each safety event of interest is summarized in [Table 1](#) and can be assigned to 1) the risk interval following Pfizer-BioNTech COVID-19 vaccination, 2) the pre-vaccination self-control interval, 3) the post-vaccination self-control interval, or 4) risk interval for the active comparators receiving seasonal influenza vaccine, and 5) risk interval for the contemporary unvaccinated controls. Events outside the intervals will not be counted.

Only the individual’s first instance of a safety event of interest following a specified clean window (i.e., the occurrence-free baseline period used to define incident outcomes during which individuals enter the study cohort only if the safety event of interest did not occur during this period) will be captured; this means that if a safety event of interest is identified but diagnosis codes corresponding to the safety event of interest are also observed during the clean window, it will not be counted. The duration of the pre-specified clean window will differ by safety event of interest (see [Appendix Table 2](#)) in order to rule out pre-existing events.

- **Key Covariates:** Baseline demographic (i.e., age, sex, state) and clinical characteristics (i.e., smoking, body mass index [BMI], history of anaphylaxis/allergic reactions, previous anaphylaxis to vaccine component, history of hospitalizations, pregnancy, Charlson Comorbidity Index [CCI], selected comorbidities, and concurrent immunizations)¹² will be assessed based on available data (i.e., during 1-year baseline) prior to the date of vaccination with Pfizer-BioNTech COVID-19 vaccine, date of seasonal influenza vaccination for active comparators, or assigned index date for contemporary unvaccinated controls.
- **Subgroups:** Pregnant women, immunocompromised individuals, elderly, individuals with specific comorbidities, those receiving only one dose of Pfizer-BioNTech

COVID-19 vaccine, and individuals with prior SARS-CoV-2 infection will be identified.

Data source: The MHS is a single payer system that provides medical coverage and pharmacy benefits for active duty and retired military members, civilian DoD personnel, and their families (beneficiaries). There are 9.6 million beneficiaries included in the MHS, of whom 1.4 million (14.6%) are active duty, 1.7 million (17.7%) are active duty family members, 392,000 (4.1%) are national guard and reserve members, 609,000 (6.3%) are family members of national guard and reserve members, and 5.47 (57.0%) million are retirees and their family members.^{13,14} The DoD includes 64 hospitals, hundreds of clinics, 25,000 uniformed physicians, and 400,000 community network providers. The population within the MHS is demographically representative of the US overall, with slight over-representation of persons >65 years of age (20.1% in DoD MHS vs. 12.9% in the general US population).¹⁵ The gender distribution is approximately 49% female and 51% male.

The DoD prioritized vaccine distribution to healthcare workers and emergency services personnel, personnel performing activities associated with critical national capabilities, select deploying individuals, other critical and essential support, individuals at the highest risk for developing severe illness from COVID-19, and adults age 75 and older.¹⁶

Study size: The sample size achieved will depend on the number of recipients of Pfizer-BioNTech COVID-19 vaccine within the DoD MHS during the study period, which will increase over time with subsequent analyses. Preliminary estimates for the number of individuals in the DoD MHS who received the Pfizer-BioNTech COVID-19 vaccine will be reported in the statistical analysis plan (SAP).

Data analysis: A stepwise process, illustrated below, will be performed for signal detection, evaluation, and verification.

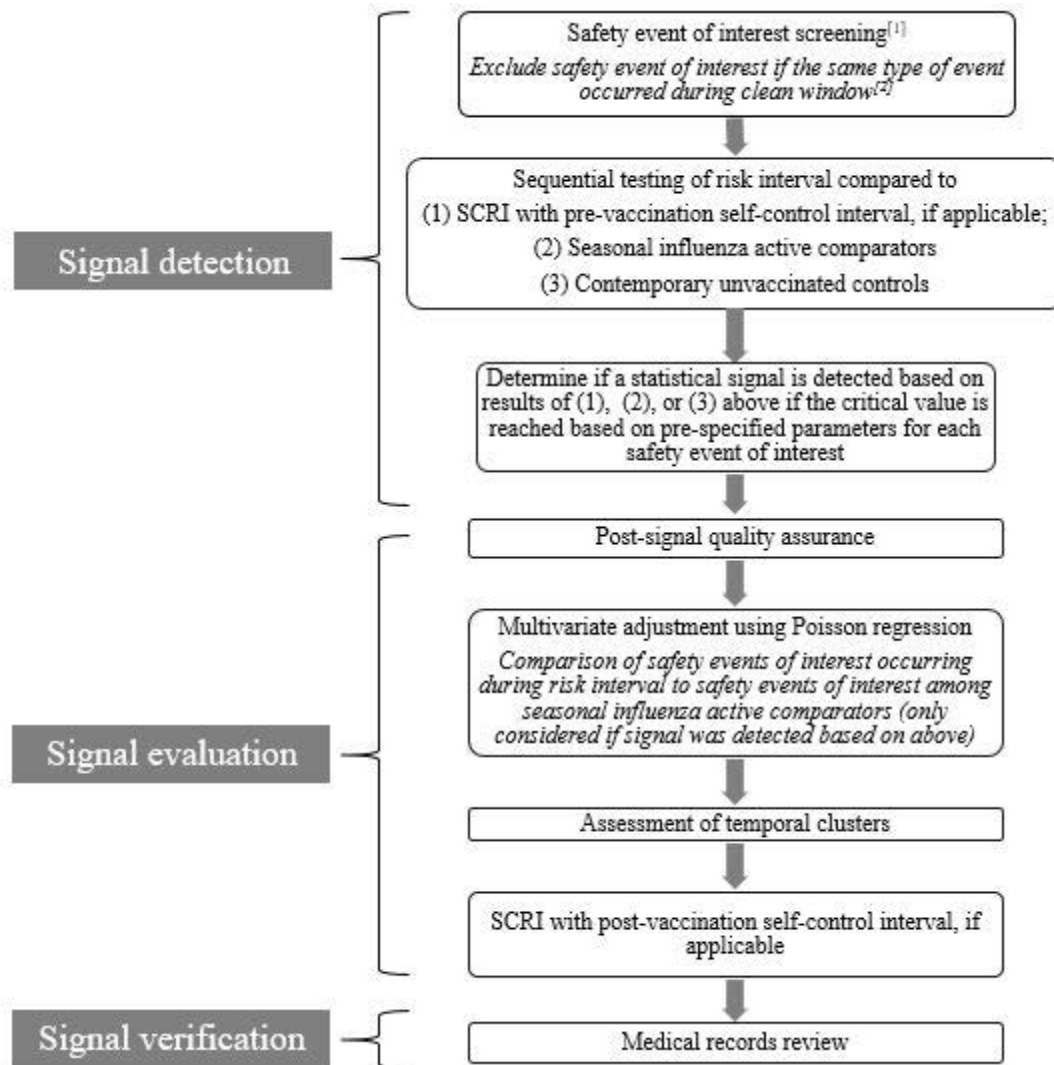

Notes:

[1] List of safety events of interest and corresponding definitions may be refined as the study progresses based on additional available information.

[2] The risk and control intervals selected for the SCRI analysis for each safety event of interest are based on biological plausibility and precedents in the literature. Only the individual's first instance during the specified clean window (i.e., the interval used to define incident outcomes) will be included. Note that only the first inpatient or outpatient occurrence of a safety event of interest following the clean window will be used to identify incident events (e.g., if an inpatient safety event of interest occurs in the clean window, a repeat occurrence will not be counted in the risk interval). However, event worsening will be counted as a safety event of interest. For example, if an outpatient safety event of interest occurs in the clean window and an inpatient occurrence for the same type of safety event of interest occurs in the risk interval, the inpatient occurrence will be counted as a safety event of interest.

1) Signal detection: The goal is to provide rapid-cycle, near real-time safety surveillance. In the signal detection phase, the SCRI analysis will only include pre-vaccination control intervals as the post-vaccination control intervals will require a longer time to accumulate and will be used in the signal evaluation phase. To account for multiple testing and repeated review of the data, e.g., monthly (to be stipulated in the SAP), the maximized sequential probability ratio test (MaxSPRT) using a binomial probability model will be applied. For comparison with individuals who received seasonal influenza vaccination, the Poisson-based

090177e1962518d5\Approved\Approved On: 29-Jan-2021 20:00 (GMT)

MaxSPRT will be applied. The comparison for the contemporary unvaccinated controls will be conducted using the binomial-based MaxSPRT method. Over time, however, the number of eligible contemporary unvaccinated controls to be matched to vaccinated individuals is expected to decrease, which will result in uncertainty in the expected number of safety events of interest. As a result, conditional Poisson MaxSPRT (CMaxSPRT) may be considered to account for error in the estimated expected number of events.

Sequential analyses for each safety event of interest will commence once at least 3 events occur. This approach is consistent with the FDA's COVID-19 Vaccine Safety Surveillance Project to avoid spurious signals from a few early events.¹⁷ Signals will be detected if the critical values are reached via the SCRI or active comparator analysis. Critical values will be determined for each safety event of interest based on historical incidence rate, expected upper limit of the number of events under the null hypothesis, pre-specified significance level, and power. Incidence rates will also be calculated, and Kaplan-Meier methods will be used to analyze time to safety events of interest.

2) Signal evaluation: If signals are detected for safety events of interest based on the analysis described above, further evaluation will be conducted to refine and confirm such detections. This will include comprehensive quality assurance (for example, check for possible duplications of claims or medical records, checking for unusual clustering in claim or medical record accrual by service date for potential coding issues, check for geographical distribution of cases that may be related to lot numbers or diagnostic practice) and multivariate adjustment using Poisson regression to account for baseline differences between Pfizer-BioNTech COVID-19 vaccinated and active comparator cohorts. SCRI analyses using the post-vaccination control intervals will be conducted as an additional inferential analysis once enough post-vaccination time has accumulated. Lastly, the assessment of temporal clustering will also be conducted.

3) Signal verification: diagnostic validation of the detected safety events of interest via adjudication of medical records by DoD MHS clinicians for outcome verification will be conducted in a representative sample of cases. For rare events, potentially all cases may be adjudicated.

End-of-season analyses (over the course of the 30-month period) and an end-of-surveillance analysis (i.e., at 30 months) will be conducted. Various subgroup analyses will also be conducted, examining different age groups, immunocompromised individuals, pregnancy, individuals with specific comorbidities patients, those who only received one dose of the Pfizer-BioNTech COVID-19 vaccine, and those with prior SARS-CoV-2 infection based on medical history or pre-vaccination serology.

Milestones:

- Registration in the EU PAS register: To be registered before the start of data collection;
- DoD Institutional Review Board (IRB) approval (estimated): 15 March 2021;

090177e1962518d5\Approved\Approved On: 29-Jan-2021 20:00 (GMT)

- Start of data collection (estimated planned date for starting data extraction for analysis): 01 May 2021;
- Interim reports: 30 June 2021; 31 December 2021; 30 June 2022, 31 December 2022;
- End of data collection (estimated planned date for final data cut): 10 June 2023;
- Final study report: 31 December 2023.

SUMMARY:

Objectives	Primary 1	Primary 2	Secondary
	To assess whether individuals in the DoD MHS experience increased risk of safety events of interest following receipt of the Pfizer-BioNTech COVID-19 vaccine.	To assess whether sub-cohorts of interest (i.e., pregnant women, immunocompromised, elderly, individuals with specific comorbidities, individuals receiving only one dose of the Pfizer-BioNTech COVID-19 vaccine, and individuals with prior SARS-CoV-2 infection) in the DoD MHS experience increased risk of safety events of interest following receipt of the Pfizer-BioNTech COVID-19 vaccine.	To characterize utilization patterns of the Pfizer-BioNTech COVID-19 vaccine among individuals within the DoD MHS, including estimating the proportion of individuals receiving vaccine, 2-dose vaccine completion rate, and distribution of time gaps between the first and second dose, demographics and health histories of recipients, overall and among the sub-cohorts of interest.
Study design	<p>This post-EUA active safety surveillance program will employ a rapid-cycle, longitudinal, observational cohort study design to provide early real-world safety information.</p> <ul style="list-style-type: none"> The self-controlled risk interval (SCRI) design will be used to sequentially monitor occurrence of safety events of interest while controlling for time-invariant confounders. The SCRI design uses data from cases (i.e., individuals who experience safety events of interest following vaccination) to compare the risk interval following vaccination to pre- or post-vaccination non-risk intervals (“pre-vaccination control interval” and “post-vaccination control interval”) in the same individual. Safety events of interest associated with Pfizer-BioNTech COVID-19 vaccinations will also be sequentially monitored and compared to two comparator populations: <ul style="list-style-type: none"> (a) Recipients of influenza vaccine in the DoD MHS during 2014/2015 through 2018/2019 flu seasons, as an active comparator. Data in peri-COVID time periods from January 2020 to present are excluded because of pandemic-associated underutilization of health resources and underreporting of medical events. (b) A sample of contemporary unvaccinated controls from the general population as reflected in the DoD MHS database, who will be identified contemporaneously with patients receiving Pfizer-BioNTech COVID-19 vaccine to reflect the background rate of current safety events of interest during the same time period. The contemporary unvaccinated controls will be randomly sampled to match the baseline demographic and clinical characteristics of individuals who receive the Pfizer-BioNTech COVID-19 vaccine (via both exact and propensity score matching, using a ratio of 1:N, but no more than 1:4 due to diminishing gains in efficiency) in order to ensure that the cohorts are comparable. 		
Study population	<p>The study will be kept as broad as possible in order to capture safety events of interest that occur among vaccinated individuals.</p> <p>Inclusion criteria:</p> <ul style="list-style-type: none"> Record of at least one dose of Pfizer-BioNTech COVID-19 vaccine; or Record of at least one dose of seasonal influenza vaccine during prior flu seasons, from 2014/2015 through 2018/2019 (as an active comparator); or No record of any COVID-19 vaccine (i.e., unvaccinated controls). <p>Exclusion criteria:</p> <ul style="list-style-type: none"> Individuals who receive at least one dose of Pfizer-BioNTech COVID-19 vaccine in addition to a COVID-19 vaccine from a manufacturer other than Pfizer-BioNTech will be identified and reported, but they will be excluded from further analysis. 		
Study Period	The study will be conducted for a period of 30 months, starting on December 11, 2020 onward, with data collection concluding on June 10, 2023.		
Exposure	<p>Administration of Pfizer-BioNTech COVID-19 vaccine post-EUA approval will be identified based on records of the following:</p> <ul style="list-style-type: none"> Current Procedural Terminology (CPT) code 91300 (Severe acute respiratory syndrome coronavirus 2 (SARS-CoV-2) (coronavirus disease [COVID-19]) vaccine, mRNA/LNP, spike protein, preservative free, 30 mcg/0.3mL dosage, diluent reconstituted, for intramuscular use) and associated vaccine 		

090177e1962518d5\Approved\Approved On: 29-Jan-2021 20:00 (GMT)

090177e1962518d5\Approved\Approved On: 29-Jan-2021 20:00 (GMT)

	<p>administration HCPCS codes corresponding to the first dose: 0001A (ADM SARS-CoV-2 30 mcg/0.3mL 1st), and the second dose: 0002A (ADM SARS-CoV-2 30 mcg/0.3mL 2nd); OR</p> <ul style="list-style-type: none"> • 10 and 11-digit National Drug Codes (NDCs) 59267-1000-1 (corresponds to first dose), 59267-1000-01 (corresponds to second dose); OR • Immunization records that contain data on vaccine code descriptor, vaccine manufacturer (i.e., Pfizer), lot number, injection site, and date(s) of immunization; <p>Administration of the seasonal influenza vaccine during 2014/2015 through 2018/2019 flu seasons will be identified based on records of the following:</p> <ul style="list-style-type: none"> • CPT codes <ul style="list-style-type: none"> ○ 90654 (Influenza virus vaccine, trivalent (IIV3), split virus, preservative-free, for intradermal use); OR ○ 90656 (Influenza virus vaccine, trivalent (IIV3), split virus, preservative free, 0.5 mL dosage, for intramuscular use); OR ○ 90658 (Influenza virus vaccine, trivalent (IIV3), split virus, 0.5 mL dosage, for intramuscular use); OR • 10 and 11-digit NDCs; OR • Immunization records that contain data on vaccine code descriptor, vaccine manufacturer, lot number, injection site, and date(s) of immunization.
<p>Safety events of interest</p>	<p>Safety events of interest for active surveillance were identified based on the Priority List of Adverse Events of Special Interest from the Brighton Collaboration’s Safety Platform for Emergency vACcines (SPEAC) Project, the FDA, and the Centers for Disease Control and Prevention’s (CDC) Advisory Committee on Immunization Practices (ACIP) enhanced safety monitoring recommendations. The list of safety events of interest may be revised over the course of the study, and if unanticipated potential safety events of interest are identified during the course of surveillance, they will be added to the list and included in the analyses. The risk and control intervals for each safety event of interest are based on biological plausibility and precedents in the literature. Outpatient (including emergency department) and/or inpatient settings will be used to identify safety events of interest, depending on the type of event. The specific encounter setting to be considered for each safety events of interest may be assigned to 1) the risk interval following Pfizer-BioNTech COVID-19 vaccination, 2) the pre-vaccination self-control interval, 3) the post-vaccination self-control interval, or 4) risk interval for the active comparators receiving seasonal influenza vaccine and contemporary unvaccinated controls. Only the individual’s first instance of a safety event of interest following a specified clean window (i.e., the occurrence-free baseline period used to define incident outcomes during which individuals enter the study cohort only if the safety event of interest did not occur during this period) will be included; this means that if a safety event of interest is identified but diagnosis codes corresponding to the safety event of interest are also observed during the clean window, it will not be counted. The duration of the pre-specified clean window will differ by safety event of interest (see Appendix Table 2) in order to rule out pre-existing events.</p> <p>Neurologic:</p> <ul style="list-style-type: none"> • Generalized convulsions/seizures • Guillain-Barré syndrome (GBS) • Aseptic meningitis • Encephalitis/encephalomyelitis • Other acute demyelinating diseases • Transverse myelitis (TM) • Multiple sclerosis (MS) • Optic neuritis (ON) • Bell’s palsy <p>Immunologic:</p> <ul style="list-style-type: none"> • Anaphylaxis • Vasculitides • Arthritis and arthralgia/joint pain • Multisystem inflammatory syndrome in adults (MIS-A) • Kawasaki disease (KD)

090177e1962518d5\Approved\Approved On: 29-Jan-2021 20:00 (GMT)

	<ul style="list-style-type: none"> • Fibromyalgia • Autoimmune thyroiditis <p>Cardiac:</p> <ul style="list-style-type: none"> • Myocarditis • Pericarditis • Acute myocardial infarction (AMI) <p>Hematologic:</p> <ul style="list-style-type: none"> • Thrombocytopenia • Disseminated intravascular coagulation (DIC) <p>COVID-19 (for all COVID-19-related safety events of interest listed below, a diagnosis of COVID-19 will be required in addition to diagnosis codes or laboratory values specified in Appendix Table 2; in addition, COVID-19 related safety events of interest will only be evaluated using data from 2020 onward using the SCRI design and unvaccinated controls only):</p> <ul style="list-style-type: none"> • Severe COVID-19 disease • Microangiopathy • Heart failure and cardiogenic shock • Stress cardiomyopathy • Coronary artery disease (CAD) • Arrhythmia • Deep vein thrombosis (DVT) • Pulmonary embolus • Cerebrovascular hemorrhagic stroke • Cerebrovascular non-hemorrhagic stroke • Limb ischemia • Hemorrhagic disease • Acute kidney injury • Liver injury • Chilblain-like lesions • Single organ cutaneous vasculitis • Erythema multiforme <p>Other:</p> <ul style="list-style-type: none"> • Pregnancy outcomes (note that outcomes related to delivery will only be assessed using active comparators and unvaccinated controls rather than SCRI since delivery will only occur at a single time point) • Death • Narcolepsy/cataplexy • Non-anaphylactic allergic reactions • Appendicitis
Data source	The DoD MHS Data Repository (MDR) will be used.

090177e1962518d5\Approved\Approved On: 29-Jan-2021 20:00 (GMT)

Data analysis	<p>A stepwise process, illustrated below, will be performed for signal detection, evaluation, and verification.</p> <p>1) Signal detection: The goal is to provide rapid-cycle, near real-time safety surveillance. In the signal detection phase, the SCRI analysis will only include pre-vaccination control intervals as the post-vaccination control intervals will require a longer time to accumulate and will be used in the signal evaluation phase. To account for multiple testing and repeated review of the data, e.g., monthly (to be stipulated in the SAP), the maximized sequential probability ratio test (MaxSPRT) using a binomial probability model will be applied. For comparison with individuals who received seasonal influenza vaccination, the Poisson-based MaxSPRT will be applied. The comparison for the contemporary unvaccinated controls will be conducted using the binomial-based MaxSPRT method. Over time, however, the number of eligible contemporary unvaccinated controls to be matched to vaccinated individuals is expected to decrease, which will result in uncertainty in the expected number of safety events of interest. As a result, conditional Poisson MaxSPRT (CMaxSPRT) may be considered to account for error in the estimated expected number of events.</p> <p>Sequential analyses for each safety event of interest will commence once at least 3 events occur. This approach is consistent with the FDA’s COVID-19 Vaccine Safety Surveillance Project to avoid spurious signals from a few early events. Signals will be detected if the critical values are reached via the SCRI or active comparator analysis. Critical values will be determined for each safety event of interest based on historical incidence rate, expected upper limit of the number of events under the null hypothesis, pre-specified significance level, and power. Incidence rates will also be calculated, and Kaplan-Meier methods will be used to analyze time to safety events of interest.</p> <p>2) Signal evaluation: If signals are detected for safety events of interest based on the analysis described above, further evaluation will be conducted to refine and confirm such signals. This will include comprehensive quality assurance (for example, check for possible duplications of claims or medical records, checking for unusual clustering in claim or medical record accrual by service date for potential coding issues, check for geographical distribution of cases that may be related to lot numbers or diagnostic practice) and multivariate adjustment using Poisson regression to account for baseline differences between Pfizer-BioNTech COVID-19 vaccinated and active comparator cohorts. SCRI analyses using the post-vaccination control intervals will be conducted as an additional inferential analysis once enough post-vaccination time has accumulated. Lastly, the assessment of temporal clustering will also be conducted.</p> <p>3) Signal verification: diagnostic validation of the detected safety events of interest via adjudication of medical records by DoD MHS clinicians for outcome verification will be conducted in a representative sample of cases. For rare events, potentially all cases may be adjudicated.</p> <p>End-of-season analyses (over the course of the 30-month period) and an end-of-surveillance analysis (i.e., at 30 months) will be conducted. Various subgroup analyses will also be conducted, examining different age groups, immunocompromised individuals, pregnancy, individuals with specific comorbidities patients, those who only received one dose of the Pfizer-BioNTech COVID-19 vaccine, and those with prior SARS-CoV-2 infection based on medical history or pre-vaccination serology.</p>
----------------------	--

5. AMENDMENTS AND UPDATES

None

090177e1962518d5\Approved\Approved On: 29-Jan-2021 20:00 (GMT)

6. MILESTONES

Milestone	Planned date
Registration in the EU PAS register	To be registered before the start of data collection
DoD IRB approval (estimated)	March 2021
Start of data collection (estimated)	May 2021 ^[1]
Interim reports	30 June 2021 31 December 2021 30 June 2022 31 December 2022
End of data collection (estimated)	10 June 2023 ^[2]
Final study report	31 December 2023

Abbreviations: DoD, Department of Defense; IRB, Institutional Review Board.

Notes:

[1] Start of data collection is the planned date for starting data extraction for the purposes of the study analysis. The initial data analysis will include the Pfizer-BioNTech COVID-19 vaccine exposure since December 11, 2020, the EUA approval date by the US FDA.

[2] End of data collection is the planned date on which the Pfizer-BioNTech COVID-19 vaccine exposure reached 30 months post EUA approval.

7. RATIONALE AND BACKGROUND

In March 2020, the World Health Organization (WHO) declared a global pandemic for the coronavirus disease 2019 (COVID-19) due to the severe acute respiratory syndrome coronavirus 2 (SARS-CoV-2), which was first identified by public health officials in China in December 2019.¹ The COVID-19 pandemic presents an unprecedented public health crisis. As of January 7, 2021, over 21.4 million COVID-19 cases and 364,000 deaths have been reported in the United States (US) alone.² To date, the incidence of COVID-19 has continued to rise, largely affecting the elderly and middle-aged individuals, with worsening clinical sequelae linked to increasing age and comorbid conditions (e.g., cardiovascular disease, active cancer, obesity, diabetes and chronic lung disease).^{18,19} SARS-CoV-2 is a well-adapted highly infectious human pathogen with a case fatality rate that ranges between 0.5% and 20%, based on the individual's age, gender, race, and comorbidities.²⁰

Pfizer and BioNTech have partnered to develop a novel messenger RiboNucleic Acid (mRNA) vaccine against SARS-CoV-2 for the prevention of COVID-19 (Candidate BNT162b2). To this end, Pfizer is conducting a Phase 1/2/3, randomized, placebo-controlled, observer-blind, dose-finding, vaccine candidate-selection, and efficacy study among healthy individuals (NCT04368728). In their Phase 1 trial evaluating safety and immunogenicity of two mRNA vaccine candidates (i.e., BNT162b1, BNT162b2) at various dose levels, candidate BNT162b2 was selected for advancement to a pivotal Phase 2/3 safety and efficacy evaluation due to its milder systemic reactogenicity profile, especially in older adults.²¹ The study was initiated in July 2020 with a target enrollment of 43,998 individuals.²²

The US Food and Drug Administration (FDA) announced that regulatory emergency use authorization (EUA) as well as full approval of any COVID-19 vaccine will require demonstrating prevention of the disease or decrease in its severity in at least 50% of the individuals who receive it. In addition, data from Phase 3 studies are required to include a median follow-up duration of at least 2 months after completion of the full vaccination regimen to assess the vaccine's benefit-risk profile, especially adverse events and cases of severe COVID-19 in vaccinated study subjects.^{23,24} The FDA reviewed the available safety data of the Phase 1/2/3 trial from 37,586 participants 16 years of age and older and did not identify any specific safety concerns. In addition, the analysis of available efficacy data from 36,523 participants 12 years of age and older without evidence of prior SARS-CoV-2 infection at least 7 days after receiving the second dose demonstrated 95% efficacy of the vaccine in the prevention of COVID-19 (as confirmed by 8 vs. 162 COVID-19 cases in the vaccine and placebo groups, respectively).^{3,4} Based on these safety and efficacy data, as well as a review of manufacturing information regarding product quality and consistency, the FDA determined that the known and potential benefits of the vaccine outweighed the known and potential risks for the prevention of COVID-19 in individuals 16 years of age and older.⁴ Therefore on December 11, 2020, the Pfizer-BioNTech COVID-19 vaccine was granted an Emergency Use Authorization (EUA) by the FDA to prevent COVID-19 in individuals 16 years of age and older.⁵

With respect to geographic regions other than the US, on December 2, 2020, the United Kingdom (UK) was the first country in the world to grant temporary authorization for

emergency use of the Pfizer-BioNTech COVID-19 vaccine.⁶ On December 21, 2020, the European Medicines Agency (EMA) granted the Pfizer-BioNTech COVID-19 vaccine a conditional marketing authorization (CMA) for use among individuals 16 years of age and older throughout all of the European Union's (EU) 27 member states.⁷

As required by the EUA, post-authorization observational studies using real-world data are needed in order to assess the association between Pfizer-BioNTech COVID-19 vaccine and pre-determined safety events of interest (including deaths, hospitalizations, and severe COVID-19) among individuals administered the vaccine in both the population at large and in populations of interest (e.g., pregnant women, immunocompromised individuals, elderly, and those with specific comorbidities).⁴ Post-authorization safety evaluations are important for identifying rare, serious safety events of interest in larger populations that may not have been detected during clinical trials (either due to sample size or selected study populations), and ensure a favorable benefit-risk ratio post-trial. Pfizer, in collaboration with Health ResearchTx (HRTx) and Analysis Group, herein proposes post-EUA active safety surveillance of safety events of interest in the Department of Defense (DoD) population based on the Priority List of Adverse Events of Special Interest from the Brighton Collaboration's Safety Platform for Emergency vACCines (SPEAC) Project, the FDA and the Centers for Disease Control and Prevention's (CDC) Advisory Committee on Immunization Practices (ACIP) enhanced safety monitoring recommendation. As part of phased allocation of COVID-19 vaccinations, all healthcare providers, emergency services, and public safety personnel within the DoD population will qualify to receive the COVID-19 vaccine.⁸ This safety surveillance study will identify and evaluate rapid, near real-time potential safety signals associated with the Pfizer-BioNTech COVID-19 vaccine in the large-scale DoD Military Health System (MHS) healthcare database, which includes both administrative claims data and clinical data from electronic medical records (EMR). The observed rates of safety events of interest will be compared to expected rates derived from self-controls, active comparators, and contemporary unvaccinated controls. Part of the methodologies used in this study are constructed based on approaches previously used by the Post-Licensure Rapid Immunization Safety Monitoring (PRISM) program for the H1N1 vaccine.⁹

This non-interventional study is designated as a Post-Authorization Safety Study (PASS) and is a commitment to the US FDA and is a Category 3 commitment in the EU Risk Management Plan.

8. RESEARCH QUESTION AND OBJECTIVES

Research question: what are the incidence rates of safety events of interest (based on adverse events of special interest [AESI]) among individuals vaccinated with the Pfizer-BioNTech COVID-19 vaccine within the US DoD MHS overall and in sub-cohorts of interest, as compared to expected rates of those events?

Primary study objectives:

- To assess whether individuals in the DoD MHS experience increased risk of safety events of interest following receipt of the Pfizer-BioNTech COVID-19 vaccine;

- To assess whether sub-cohorts of interest (i.e., pregnant women, immunocompromised, elderly, individuals with specific comorbidities, individuals receiving only one dose of the Pfizer-BioNTech COVID-19 vaccine, and individuals with prior SARS-CoV-2 infection) in the DoD MHS experience increased risk of safety events of interest following receipt of the Pfizer-BioNTech COVID-19 vaccine.

Secondary study objective:

- To characterize utilization patterns of the Pfizer-BioNTech COVID-19 vaccine among individuals within the DoD MHS, including estimating the proportion of individuals receiving vaccine, 2-dose vaccine completion rate, and distribution of time gaps between the first and second dose, demographics and health histories of recipients, overall and among the sub-cohorts of interest.

9. RESEARCH METHODS

9.1. Study Design

This post-EUA active safety surveillance program will employ a rapid-cycle, longitudinal, observational cohort study design to provide early real-world safety information.

- The self-controlled risk interval (SCRI) design will be used to sequentially monitor occurrence of safety events of interest while controlling for time-invariant confounders (such as sex, race, chronic illness, and state).
- Safety events of interest associated with Pfizer-BioNTech COVID-19 vaccinations will be sequentially monitored and compared to two comparator populations:

(a) Recipients of influenza vaccine in the DoD MHS during 2014/2015 through 2018/2019 flu seasons, as an active comparator. This will be particularly helpful to assess rarer safety events of interest occurring with Pfizer-BioNTech COVID-19 vaccinations and compared to recipients of influenza vaccine in the DoD MHS between 2014/2015 to 2018/2019.^{9,25}

(b) A sample of contemporary unvaccinated matched controls in the DoD MHS, as a general population comparator group, who will be identified during the same time period as individuals receiving Pfizer-BioNTech COVID-19 vaccine to reflect the background rate of current safety events of interest. This analysis will be conducted in order to evaluate risk as compared to a comparable general population of individuals who do not receive any COVID-19 vaccine in the DoD MHS and provide context for interpretation of excess risk identified.

9.1.1. Self-Controlled Risk Interval (SCRI) Design

The SCRI design uses data from cases (i.e., individuals who experience safety events of interest following vaccination) to compare the risk interval following vaccination to pre- or post-vaccination non-risk intervals (“pre-vaccination control interval” and “post-vaccination

control interval”) in the same individual.²⁶ Whether a pre- or post-vaccination control interval is used will depend on the clinical nature, seasonality, and frequency of the safety event of interest, as described in greater detail below. A length of 42 days has been used to define the risk interval in SCRI design studies for signal detection to ascertain the safety profile of the H1N1 vaccine.^{9,25} The same length of risk interval is proposed here, subject to further modification based on clinical input, clinical trial data, biologic plausibility, and published literature. The day of vaccination will only be included in the risk period for those safety events of interest for which a same-day occurrence is biologically plausible (e.g., anaphylaxis).

As some individuals may choose to decline or delay Pfizer-BioNTech COVID-19 vaccination soon after an illness (known as the “healthy vaccinee effect”),²⁷ the pre-vaccination control interval will exclude the 14-day period before vaccination.²⁸ While using a pre-vaccination control period allows for timely analysis, especially pertinent for rarer safety events of interest, a post-vaccination control interval would be more appropriate and will be used for certain safety events of interest for the following reasons (1) a recent prior safety event of interest might preclude vaccination (i.e., anaphylaxis), (2) individuals might have an underlying condition that is also a contraindication for vaccination (i.e., seizure disorder), or (3) safety events of interest and vaccination may be seasonal in nature.²⁹ The time between the risk and control intervals will be determined based on the biological mechanism of action for each safety event of interest assessed, and may be subject to change based on further clinical input. Examples of the SCRI design with a pre-vaccination control interval and a post-vaccination control interval (in an individual who only receives the first dose of vaccine) are presented in [Figure 1](#) below.

090177e1962518d5\Approved\Approved On: 29-Jan-2021 20:00 (GMT)

Figure 1. Example of SCRI Design for Assessment of a Safety Event of Interest with a 42-day Risk Interval in an Individual who Receives Only One Vaccine Dose, Showing Both Pre- and Post-vaccination Control Intervals

A) Safety event pre-vaccination control interval

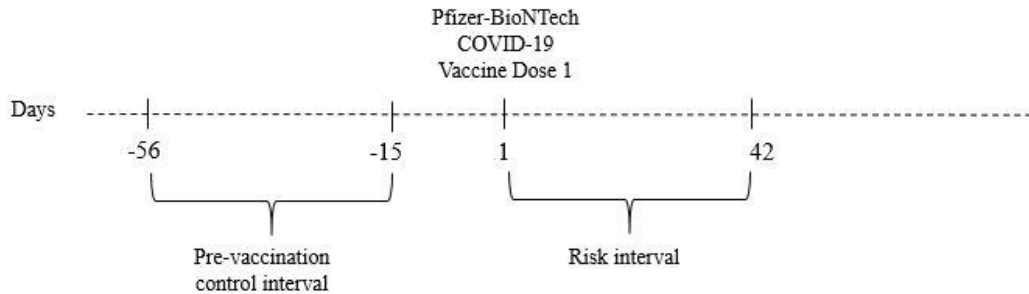

B) Safety event post-vaccination control interval

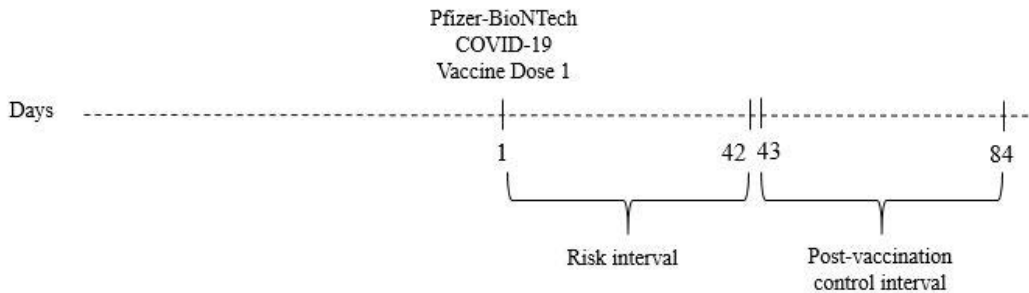

*The risk interval may include day 0, date of Pfizer-BioNTech COVID-19 vaccination, for some of the safety events of interest assessed (e.g., anaphylaxis). The length of the risk interval will vary across each safety event of interest and may be subject to change based on clinical input. Note that some individuals may not receive the complete course of vaccination, and thus may only receive the first dose of vaccine. This is represented in

Figure 1 while Figure 2 represents an example where the complete course with 2 doses are received.

Two doses of the Pfizer-BioNTech COVID-19 vaccine are recommended 3 weeks apart. This study program will monitor safety events of interest that occur after dose 1 and before dose 2 (i.e., during risk interval 1), after dose 2 (i.e., during risk interval 2), and aggregate for doses 1 and 2 (i.e., risk interval 1 + risk interval 2), respectively, for individuals receiving both doses.

For individuals who receive two doses of the vaccine, two separate control intervals will be defined to correspond to the risk interval associated with each dose (regardless of whether pre- or post-vaccination control intervals are used). See Figure 2 below for an example in an individual who receives two doses of Pfizer-BioNTech COVID-19 vaccine, with the second dose received 21 days after the first. Safety events of interest that occur during the overlapping period of risk interval 1 and risk interval 2 (shown in gray shading in Figure 2) may be flagged for separate analyses to discern the additive effect of Pfizer-BioNTech COVID-19 vaccine dose 1 and dose 2.

090177e1962518d5\Approved\Approved On: 29-Jan-2021 20:00 (GMT)

Figure 2. Example of SCRI Design with Overlapping Risk Intervals when Two Doses of Pfizer-BioNTech COVID-19 Vaccine are Administered, Showing a Pre- and Post-vaccination Control Interval

A) Safety event pre-vaccination control intervals

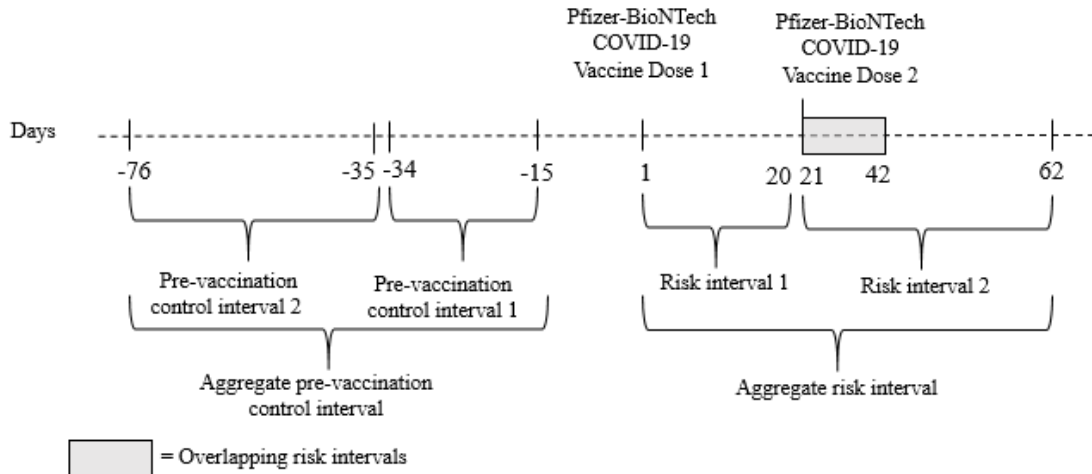

B) Safety event of interest post-vaccination control intervals

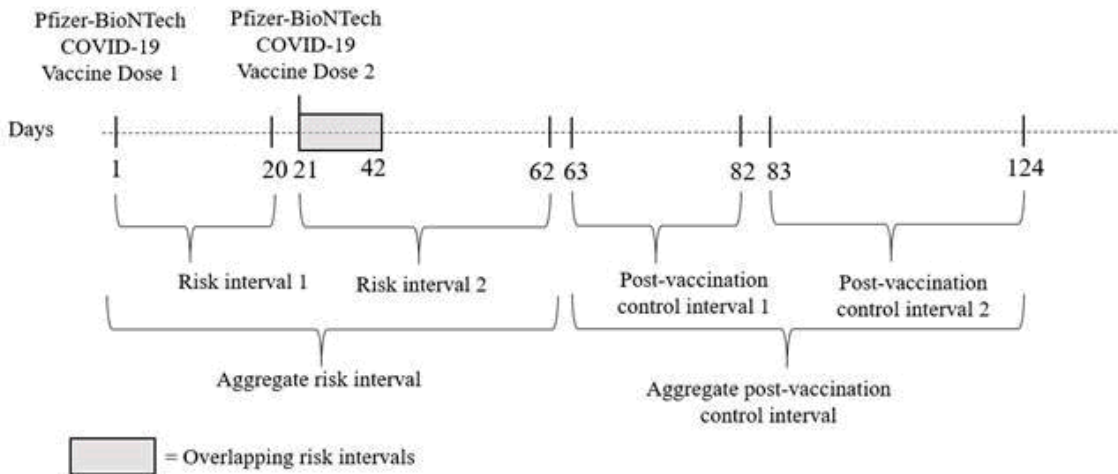

9.1.2. Active Comparator Design

In the active comparator design, the frequency of safety events of interest among individuals who received Pfizer-BioNTech COVID-19 vaccine from December 11, 2020 onward will be compared with the event frequency among individuals who received the seasonal influenza

090177e1962518d5\Approved\Approved On: 29-Jan-2021 20:00 (GMT)

vaccination in five prior seasons, between 2014/2015 through 2018/2019. Data in peri-COVID time periods from January 2020 to present are excluded because of pandemic-associated underutilization of health resources and underreporting of medical events. The same risk interval length (e.g., 42 days) will be used to evaluate safety events of interest following vaccination with Pfizer-BioNTech COVID-19 vaccine and to assess safety events of interest occurring after vaccination for seasonal influenza in prior seasons. The observed number of safety events of interest for Pfizer-BioNTech COVID-19 vaccine will be compared to the expected number calculated for the influenza vaccine in past seasons.⁹

9.1.3. Contemporary Unvaccinated Control Design

A contemporary matched comparator cohort of individuals who are not vaccinated with any COVID-19 vaccine will be identified and serve as contemporary unvaccinated controls during the period December 11, 2020 onward. These individuals will be randomly sampled from the general population to match the baseline demographic and clinical characteristics of individuals who receive the Pfizer-BioNTech COVID-19 vaccine in order to ensure that the populations are comparable. Specifically, issues of non-comparability between vaccinated and contemporary unvaccinated controls will be addressed via exact matching (1:N, but no greater than 1:4 due to diminishing gains in efficiency with higher ratios)³⁰ on age, sex, state, and key conditions known to increase the risk of severe COVID-19 (e.g., cancer, obesity, pregnancy, smoking, type 2 diabetes, etc.).¹² In addition, patients will be matched on whether or not they received a seasonal influenza vaccine and the timing of vaccination with seasonal influenza vaccine in relation to vaccination with Pfizer-BioNTech COVID-19 vaccine, as receipt of influenza vaccine close to COVID-19 vaccination may impact occurrence of safety events of interest. Additional covariates of clinical significance will be adjusted for via propensity score (PS) matching. Matched samples allow one to estimate the treatment effect by directly comparing the outcome(s) of interest between the vaccinated and unvaccinated matched sample.³¹ This approach parallels that of a randomized control trial, where the distribution of covariates is similar between treatment arms.³¹

The index date for the contemporary unvaccinated controls will be selected based on the distribution of index dates in the vaccinated cohort. If vaccination is associated with a regular healthcare encounter (i.e., an evaluation and management code or similar), the contemporary unvaccinated control will be required to have an encounter within 30 days of the assigned index date, and the date of encounter will be set as the index date to ensure comparability of covariate measurement.

Additionally, there is a theoretical risk that vaccination could result in vaccine-associated enhanced disease (VAED), i.e., exacerbation of viral infection resulting in more severe illness or specific clinical manifestations upon exposure to SARS-CoV-2 as compared with what would have been experienced without vaccination. To evaluate this potential risk and identify such a signal, patterns of serious COVID-19 illness will be evaluated between vaccinated and contemporary unvaccinated controls. The self-controlled design would not be appropriate for evaluating VAED as the timing of exposure to the wild-type virus would impact this outcome. Incidence rates will be calculated, compared, and stratified by categories of age and presence or absence of risk factors for severe disease. An apparent excess of serious COVID-19 illness in the reference populations, such as young individuals

and/or individuals without risk factors (i.e., individuals at low risk for severe disease) may be indicative of VAED, and would warrant further evaluation (e.g., chart review).

9.1.4. Study Period

The study will be conducted for a period of 30 months, starting on December 11, 2020 onward, with data collection concluding on June 10, 2023.

9.2. Setting

The exposed population will be kept as broad as possible in order to capture safety events of interest that occur among all individuals receiving Pfizer-BioNTech COVID-19 vaccine.

9.2.1. Inclusion Criteria

- Record of at least one dose of Pfizer-BioNTech COVID-19 vaccine in the period of December 11, 2020 to present; or
- Record of at least one dose of seasonal influenza vaccine during prior flu seasons, from 2014/2015 to 2018/2019 (applies to active comparators only); or
- No record of any COVID-19 vaccine (applies to the contemporary unvaccinated controls only); and
- At least 1 year of continuous enrollment (i.e., the baseline period) prior to date of Pfizer-BioNTech COVID-19 vaccination, seasonal influenza vaccination, or matched index date for unvaccinated controls.

9.2.2. Exclusion criteria

- Individuals who receive at least one dose of COVID-19 vaccine from a manufacturer other than Pfizer-BioNTech will be identified and reported, but they will be excluded from further analysis.

9.2.3. Subgroups

Safety surveillance may be conducted for subgroups of interest, including, but not limited to:

- Pregnant women;
- Immunocompromised individuals;
- Different age groups, with a focus on the elderly (e.g., <35, 35 to <45, 45 to <55, 55 to <65, 65 to <75, ≥ 75);
- Individuals with specific comorbidities;
- Individuals receiving only one dose of Pfizer-BioNTech COVID-19 vaccine;

- Individuals with prior SARS-CoV-2 infection based on medical history or pre-vaccination serology.

Additional subgroups of interest will be assessed as additional information becomes available from ongoing clinical trials, Vaccine Adverse Event Reporting System (VAERS), and other sources that will inform the Pfizer-BioNTech COVID-19 vaccine safety profile.

9.3. Variables

9.3.1. Exposure of Interest

Administration of Pfizer-BioNTech COVID-19 vaccine post-EUA approval will be identified based on the following:

- Current Procedural Terminology (CPT) code 91300 (Severe acute respiratory syndrome coronavirus 2 (SARS-CoV-2) (coronavirus disease [COVID-19]) vaccine, mRNA/LNP, spike protein, preservative free, 30 mcg/0.3mL dosage, diluent reconstituted, for intramuscular use) and associated vaccine administration HCPCS codes corresponding to the first dose: 0001A (ADM SARS-CoV-2 30 mcg/0.3mL 1st), and the second dose: 0002A (ADM SARS-CoV-2 30 mcg/0.3mL 2nd);^{10,11} OR
- 10 and 11-digit National Drug Codes (NDCs) 59267-1000-1 (corresponds to first dose), 59267-1000-01 (corresponds to second dose); OR
- Immunization records that contain data on vaccine code descriptor, vaccine manufacturer (i.e., Pfizer), lot number, injection site, and date(s) of immunization.¹⁰

Relevant codes will be continuously reviewed and amended if new codes are added.

Person-time at-risk exposure to the first dose only, overlapping first and second doses, and second dose only will be analyzed separately.

Administration of the seasonal influenza vaccine during 2014/2015 through 2018/2019 flu seasons will be identified based on the following:

- CPT codes
 - 90654 (Influenza virus vaccine, trivalent (IIV3), split virus, preservative-free, for intradermal use); OR
 - 90656 (Influenza virus vaccine, trivalent (IIV3), split virus, preservative free, 0.5 mL dosage, for intramuscular use); OR
 - 90658 (Influenza virus vaccine, trivalent (IIV3), split virus, 0.5 mL dosage, for intramuscular use); OR
- 10 and 11-digit NDCs; OR

- Immunization records that contain data on vaccine code descriptor, vaccine manufacturer, lot number, injection site, and date(s) of immunization.

9.3.1.1. Pfizer-BioNTech COVID-19 Vaccine Groups of Interest

While the primary vaccination group of interest is all individuals receiving Pfizer-BioNTech COVID-19 vaccine (irrespective of receipt of seasonal influenza vaccination), additional subsets of the study population will be studied, similar to the PRISM safety surveillance program of H1N1 vaccine safety:⁹

Cohort A: Individuals vaccinated with Pfizer-BioNTech COVID-19 vaccine who did not receive the influenza vaccine during the flu season in which COVID-19 vaccination occurred;

Cohort B: Individuals vaccinated with Pfizer-BioNTech COVID-19 vaccine who received the seasonal influenza vaccine at least 42 days prior to COVID-19 vaccination during the same flu season in which COVID-19 vaccination occurred;

Cohort C: Individuals vaccinated with Pfizer-BioNTech COVID-19 vaccine who received the seasonal influenza vaccine within 42 days before or any time after COVID-19 vaccination during the same flu season in which COVID-19 vaccination occurred;

Cohort D: Individuals vaccinated with both Pfizer-BioNTech COVID-19 vaccine and the seasonal influenza vaccine on the same day.

The following sub-cohorts will be assessed for each of the Cohorts A-D:

- Individuals vaccinated with only 1 dose (i.e., incomplete course) of Pfizer-BioNTech COVID-19 vaccine;
- Individuals vaccinated with 2 doses (i.e., complete course) of Pfizer-BioNTech COVID-19 vaccine.

9.3.2. Baseline Characteristics

The following data elements regarding baseline demographic and clinical characteristics will be assessed based on a 1-year baseline period prior to the date of vaccination with Pfizer-BioNTech COVID-19 vaccine, date of seasonal influenza vaccination for active comparators, and assigned index date for contemporary unvaccinated controls. Depending on the attrition rate, the length of the baseline period may be modified to 6 months. All diagnoses, procedures, and medications will be identified by the International Classification of Diseases, Tenth Revision, Clinical Modification (ICD-10-CM) diagnosis codes, ICD-10-PCS (procedure coding system) codes, ICD-10-CM Current Procedural Terminology (CPT), and Logical Observation Identifiers Names and Codes (LOINC) laboratory results, or Healthcare Common Procedure Coding System (HCPCS) procedure codes, and generic drug names, as appropriate (see [Appendix Table 1](#)). The following demographic and clinical characteristics will be assessed:

Demographics:

- Age
- Sex
- State
- Sponsor service (e.g., Air Force, Army, Coast Guard, Marine Corps, Navy)
- Category of beneficiary (e.g., active duty, retiree, active guard/reserve, dependent)

Clinical characteristics:

- Smoking status
- Body mass index (BMI)
- History of anaphylaxis/allergic reactions
- Previous anaphylaxis of vaccine component
- History of hospitalizations
- Pregnancy
- Charlson comorbidity index (CCI)
- Selected comorbidities
 - Autoimmune disease
 - Asthma
 - Bleeding diathesis or condition associated with prolonged bleeding
 - Cancer
 - Cardiovascular conditions
 - Chronic kidney disease/dialysis
 - Chronic obstructive pulmonary disease (COPD)/interstitial lung disease
 - Diabetes mellitus
 - Down syndrome
 - Sickle cell disease
 - Hepatitis B virus (HBV)
 - Hepatitis C virus (HCV)
 - Human immunodeficiency virus (HIV)
 - Hyperlipidemia
 - Hypertension
 - Liver disease
 - Neurological disease
 - Other immune deficiencies
 - Solid organ transplant
 - Venous thromboembolism (VTE)
- Concurrent immunizations
 - Seasonal influenza vaccine
 - Tetanus diphtheria and pertussis (Tdap or Td)
 - Chickenpox (varicella)
 - Shingles (herpes zoster recombinant and/or live)
 - Human papillomavirus (HPV)
 - Pneumococcal conjugate

- Pneumococcal polysaccharide
- Hepatitis A
- Hepatitis B
- Meningococcal conjugate (MenACWY) and serogroup B meningococcal (MenB)
- Haemophilus influenza type b

9.3.3. Outcomes

The safety events of interest for active surveillance were identified based on the Priority List of Adverse Events of Special Interest from the Brighton Collaboration's Safety Platform for Emergency vACcines (SPEAC) Project and the FDA and Centers for Disease Control and Prevention (CDC) enhanced safety monitoring recommendations.^{32,33} Endpoints of special interest in signal detection, as noted by CDC's Advisory Committee on Immunization Practices (ACIP) are denoted in italics.³³ The list of safety events of interest may be revised over the course of the study, and if unanticipated potential safety events of interest are identified during the course of surveillance, they will be added to the list and included in the analyses. See [Appendix Table 2](#) for the operational definitions of the outcome variables based on ICD-10-CM diagnosis codes and LOINC laboratory codes, which may be refined as the study progresses based on additional available information and the published literature (e.g., frequency of ICD-10 codes). Outpatient (including emergency department) and/or inpatient settings will be used to identify safety events of interest, depending on the type of event. The specific encounter setting considered for each safety event of interest is summarized in [Table 1](#). Any record of death will be captured, regardless of whether the individual died in a healthcare or non-healthcare setting. The following safety events of interest will be assessed:

Neurologic:

- *Generalized convulsions/seizures*
- *Guillain-Barré syndrome (GBS)*
- Aseptic meningitis
- Encephalitis/encephalomyelitis
- Other acute demyelinating diseases
- Transverse myelitis (TM)
- Multiple sclerosis (MS)
- Optic neuritis (ON)
- Bell's palsy

Immunologic:

- Anaphylaxis
- Vasculitides
- Arthritis and arthralgia/joint pain
- *Multisystem inflammatory syndrome in adults (MIS-A)*
- *Kawasaki disease (KD)*

- Fibromyalgia
- Autoimmune thyroiditis

Cardiac:

- *Myocarditis*
- *Pericarditis*
- *Acute myocardial infarction (AMI)*

Hematologic:

- *Thrombocytopenia*
- *Disseminated intravascular coagulation (DIC)*

COVID-19 (for all COVID-19-related safety events of interest listed below, an inpatient diagnosis of COVID-19 will be required in combination with the codes or laboratory values specified in [Appendix Table 2](#); in addition, COVID-19 related safety events of interest will only be evaluated using data from 2020 onward using the SCRI design and contemporary unvaccinated controls):

- *Severe COVID-19 disease*
- Microangiopathy
- Heart failure and cardiogenic shock
- Stress cardiomyopathy
- Coronary artery disease (CAD)
- Arrhythmia
- Deep vein thrombosis (DVT)
- Pulmonary embolus
- *Cerebrovascular hemorrhagic stroke*
- *Cerebrovascular non-hemorrhagic stroke*
- Limb ischemia
- Hemorrhagic disease
- Acute kidney injury
- Liver injury
- Chilblain-like lesions
- Single organ cutaneous vasculitis
- Erythema multiforme

Other:

- Pregnancy outcomes (note that outcomes related to delivery will only be assessed using active comparators and contemporary unvaccinated controls rather than SCRI since delivery will only occur at a single time point)
- *Death*
- *Narcolepsy/cataplexy*

- Non-anaphylactic allergic reactions
- Appendicitis

The risk and control intervals selected for the SCRI analysis for each safety event of interest are based on biological plausibility and precedents in the published literature (Table 1). A safety event of interest will be counted if it can be assigned to 1) the risk interval following Pfizer-BioNTech COVID-19 vaccination, 2) the pre-vaccination control interval, 3) the post-vaccination control interval, or 4) the risk interval for the active comparators receiving seasonal influenza vaccine, and 5) risk interval for the contemporary unvaccinated controls. Events outside the intervals will not be counted. Only the individual's first instance of a safety event of interest following a specified clean window (i.e., the occurrence-free baseline period used to define incident outcomes during which individuals enter the study cohort only if the safety event of interest did not occur during this period) will be included; this means that if a safety event of interest is identified but diagnosis codes (or laboratory values in the case of select safety events of interest) corresponding to the safety event of interest are also observed during the clean window, it will not be counted. The duration of the pre-specified window will differ by safety events of interest in order to rule out pre-existing events. This approach is consistent with the FDA's COVID-19 Vaccine Safety Surveillance Project.¹⁷ By way of example, safety events of interest for the SCRI design can be considered in the following ways:

- If a safety event of interest occurs in the individual's pre-vaccination control interval and there are no other diagnosis codes for the same safety event of interest in the clean window (e.g., 1-year prior to that date), the safety event of interest should be assigned to the pre-vaccination control interval.
 - If a safety event of interest occurs in the pre-vaccination control interval but another diagnosis code for the same safety event of interest is identified during the risk interval, then the safety event of interest will not be assigned to the risk interval and will only be assigned to the pre-vaccination control interval as it will have occurred in the required clean window preceding the risk interval. However, if an outpatient safety event of interest occurs in the clean window and an inpatient occurrence for the same type of safety event of interest occurs in the risk interval, the inpatient occurrence will be counted in order to capture event exacerbation.
- If a safety event of interest occurs in the risk interval and there are no other diagnoses for the same safety event of interest in the clean window (e.g., 1-year prior to this date), which also includes the pre-vaccination control interval, then the safety event of interest will be assigned to the risk interval.
- The same approach will be applied for the post-vaccination control intervals.

The risk intervals for outcome evaluation for the active comparators (i.e., individuals who received seasonal influenza vaccination) and contemporary unvaccinated controls (i.e.,

individuals who did not receive the Pfizer-BioNTech COVID-19 vaccine) will be the same as for the individuals who received Pfizer-BioNTech COVID-19 vaccine.

However, it is possible that some safety events of interest do not have a precise time interval from which to evaluate risk, for example if biological plausibility is unknown or the diagnostic time window is more delayed than anticipated. In these cases, misspecification of the risk (and control) intervals could result in misclassification and introduce bias, often toward the null. For instance, the assumption of a longer risk interval than is true may result in “washing out” the signal, and an erroneously short risk interval may similarly result in underestimation of effect when using post-vaccination time intervals for self-control. To address this, sensitivity analyses may be conducted with varying risk intervals (longer as well as shorter) in order to increase the likelihood that the safety risk is detected accurately. Additionally, if further refinement and evaluation is necessary, temporal scan statistics may be used to empirically identify the at-risk time interval by evaluating clusters of safety events of interest. This will be further described in the statistical analysis plan (SAP).

Table 1. Outcome algorithms for SCRI analysis, with risk and control intervals

Safety event of Interest*	Setting (Inpatient [IP], Outpatient [OP])	Clean window	Pre-vaccination control interval (days)	Risk interval (days)	Post-vaccination control interval (days)
Neurologic					
Generalized convulsion/seizures ⁹	IP or OP ⁹	6 months	N/A	0-14	15-29
GBS ^{9,25}	IP, primary position only ¹⁷	1 year	N/A	1-42	43-84
Aseptic meningitis ³⁴	IP only ¹⁷	1 year	N/A	1-42	43-84
Encephalitis/encephalomyelitis ⁹	IP only ¹⁷	1 year	-56 through -15	1-42	N/A
Other acute demyelinating diseases ⁹	IP or OP ⁹	1 year	-98 through -15	1-42	N/A
TM ^a	IP only ¹⁷	1 year	-98 through -15	1-42	N/A
MS ^{9,25}	IP or OP ⁹	1 year	-98 through -15	1-42	N/A
ON ^{9,25}	IP or OP ⁹	1 year	-98 through -15	1-42	N/A
Bell's palsy ^{9,25}	IP or OP ¹⁷	1 year	-56 through -15	1-42	N/A
Immunologic					
Anaphylaxis ^{9,25}	IP or OP ¹⁷	6 months	N/A	0-2	7-9
Vasculitides ^e	IP only	1 year	N/A	1-28	29-56
Arthritis and arthralgia/joint pain ^c	IP or OP	1 year	N/A	1-42	43-84
MIS-A ^b	IP only ¹⁷	1 year	N/A	1-42	43-84
KD ³⁵	IP only ³⁵	1 year	N/A	1-28	29-56
Fibromyalgia ^c	IP or OP	1 year	N/A	1-42	43-84
Autoimmune thyroiditis ^c	IP or OP	1 year	N/A	1-42	43-84
Cardiac					
Myocarditis ^{9,25}	IP or OP ¹⁷	1 year	-56 through -15	1-42	N/A
Pericarditis ^{9,25}	IP or OP ¹⁷	1 year	-56 through -15	1-42	N/A
AMI ^d	IP only ¹⁷	1 year	-56 through -15	1-42	N/A
Hematologic					
Thrombocytopenia ³⁴	IP or OP ¹⁷	1 year	N/A	1-42	43-84
DIC ^e	IP only ¹⁷	1 year	N/A	1-42	43-84

090177e1962518d5\Approved\Approved On: 29-Jan-2021 20:00 (GMT)

Table 1. Outcome algorithms for SCRI analysis, with risk and control intervals

Safety event of Interest*	Setting (Inpatient [IP], Outpatient [OP])	Clean window	Pre-vaccination control interval (days)	Risk interval (days)	Post-vaccination control interval (days)
COVID-19 (for all COVID-19-related safety events of interest listed below, an inpatient diagnosis of COVID-19 will be required in combination with the codes or laboratory values specified in Appendix Table 2 ; in addition, COVID-19 related safety events of interest will only be evaluated using data from 2020 onward using the SCRI design and contemporary unvaccinated controls)					
Severe COVID-19 disease ^b	IP only	1 year	N/A	1-42	43-84
Microangiopathy ^c	IP only	1 year	N/A	1-42	43-84
Heart failure and cardiogenic shock ^d	IP only	1 year	-56 through -15	1-42	N/A
Stress cardiomyopathy ^d	IP only	1 year	-56 through -15	1-42	N/A
CAD ^d	IP only	1 year	-56 through -15	1-42	N/A
Arrhythmia ^d	IP only	1 year	-56 through -15	1-42	N/A
DVT ^e	IP or OP ¹⁷	1 year	N/A	1-42	43-84
Pulmonary embolus ^e	IP or OP ¹⁷	1 year	N/A	1-42	43-84
Cerebrovascular hemorrhagic stroke ⁹	IP only ¹⁷	1 year	N/A	1-42	43-84
Cerebrovascular non-hemorrhagic stroke ⁹	IP only ¹⁷	1 year	N/A	1-42	43-84
Limb ischemia ^e	IP only	1 year	N/A	1-42	43-84
Hemorrhagic disease ^e	IP only	1 year	N/A	1-42	43-84
Acute kidney injury ^g	IP only	6 months	N/A	1-42	43-84
Liver injury ^g	IP or OP	1 year	N/A	1-42	43-84
Chillblain-like lesions ^e	IP or OP	1 year	N/A	1-42	43-84
Single organ cutaneous vasculitis ^e	IP only	1 year	N/A	1-42	43-84
Erythema multiforme ^f	IP only	6 months	N/A	1-2	8-9
Other					
Pregnancy outcomes ^{36,h}	IP or OP	1 year	N/A	1-42	43-84
Narcolepsy and cataplexy ^a	IP or OP ¹⁷	1 year	-98 through -15	1-42	N/A
Non-anaphylactic allergic reactions ^{9,25}	IP or OP ⁹	6 months	N/A	1-2	8-9
Appendicitis ³⁷	IP only ¹⁷	6 months	N/A	0-42	43-84

090177e1962518d5\Approved\Approved On: 29-Jan-2021 20:00 (GMT)

Table 1. Outcome algorithms for SCRI analysis, with risk and control intervals

Safety event of Interest*	Setting (Inpatient [IP], Outpatient [OP])	Clean window	Pre-vaccination control interval (days)	Risk interval (days)	Post-vaccination control interval (days)
---------------------------	---	--------------	---	-------------------------	--

*Safety events of interest are based on the Priority List of Adverse Events of Special Interest from the Brighton Collaboration’s Safety Platform for Emergency vACCines (SPEAC) Project, the FDA and the Centers for Disease Control and Prevention’s (CDC) Advisory Committee on Immunization Practices (ACIP) enhanced safety monitoring recommendations.

Notes:

- ^a Published risk and control intervals for demyelinating diseases and cranial disorders were applied to TM and narcolepsy/cataplexy.
- ^b As severe COVID-19 ranges from severe pneumonia, acute respiratory distress syndrome, and multisystem organ failure/MIS-A, a 1-42 day risk interval was applied in order to capture the 14-day incubation period of the disease and 4-5 day period from exposure to symptom onset.
- ^c Published risk and control intervals for autoimmune disorders were applied to similar autoimmune rheumatic conditions (i.e., fibromyalgia and autoimmune thyroiditis).
- ^d Published risk and control intervals for myocarditis and pericarditis were applied to other cardiovascular conditions (i.e., heart failure and cardiogenic shock, stress cardiomyopathy, CAD, arrhythmia, AMI).
- ^e Similar risk and control intervals were applied to all cardiovascular and hematological disorders characterized by damage to the blood vessels and/or arteries and clotting (i.e., microangiopathy, DVT, pulmonary embolus, limb ischemia, hemorrhagic disease, DIC, chilblain-like lesions). The published risk and control intervals for KD were applied to vasculitides given that KD is a type of medium and small-vessel vasculitis.
- ^f Published risk and control intervals for non-anaphylactic allergic reactions were applied to hypersensitivity disorders (i.e., erythema multiforme).
- ^g Risk intervals of 42 days were applied for acute kidney injury and liver injury to be consistent with other COVID-19 related safety events of interest.
- ^h Pregnancy outcome of eclampsia/pre-eclampsia only will be assessed using SCRI. Other pregnancy outcomes that are related to delivery (i.e., post-partum hemorrhage, premature rupture of membranes, chorioamnionitis, placental abruption, and cesarean section) will be evaluated using the active comparator and contemporary unvaccinated control designs.

090177e1962518d5\Approved\Approved On: 29-Jan-2021 20:00 (GMT)

9.4. Data Source

This study will be conducted in the DoD Military Health System (MHS) database. The MHS is a single payer system that provides medical coverage and pharmacy benefits for active duty and retired military members, civilian DoD personnel, and their families (beneficiaries). Veterans who receive medical coverage through the Veterans Health Administration are not included. There are 9.6 million beneficiaries included in the MHS, of whom 1.4 million (14.6%) are active duty, 1.7 million (17.7%) are active duty family members, 392,000 (4.1%) are national guard and reserve members, 609,000 (6.3%) are family members of national guard and reserve members, and 5.5 (57.3%) million are retirees and their family members.^{13,14} The DoD also includes 64 hospitals, hundreds of clinics, 25,000 uniformed physicians, and 400,000 community network providers. The population within the MHS is demographically representative of the US overall, with slight over-representation of persons >65 years of age (20.1% in DoD MHS vs. 12.9% in the general US population).¹⁵ The gender distribution is approximately 49% female and 51% male.

The MHS provides care in two ways: direct and purchased care. Direct care is provided to beneficiaries within a global network of military hospitals and clinics. MHS uses an EMR that captures administrative and encounter information, as well as a detailed clinical record. Purchased care (through TRICARE, the DoD health insurance) is provided to beneficiaries by civilian providers who are paid via fee-for-service reimbursements or managed care contracts. MHS collects and verifies encounter and claims records for each service.³⁸

All healthcare encounters, whether received through direct or purchased care, are archived, validated, and normalized within a central MHS Data Repository (MDR). For those receiving direct care, all medical services are captured, as well as clinical details, diagnostic and laboratory test ordered, and test results. Information is collected at the point of care and available almost immediately. Direct care accounts for approximately 40% of care within the MHS, though this proportion may change over time.³⁹ The MHS purchased care data include records of physician services, hospital care (inpatient and outpatient), emergency room visits, home health, hospice, and other services. Claims for laboratory and diagnostic testing are collected; however, unlike direct care, the results of these tests are not captured.

Prescription data from both direct and purchased care are captured within MHS's electronic medication ordering system called the Pharmacy Data Transaction System (PDTS). Dispensing details and physician-administered medication events are coded electronically and include the prescribed drug name and NDCs, dose, therapeutic class, quantity, refills, and fill location. Vaccination records include data on the vaccine code descriptor, vaccine manufacturer, lot number, injection site, and date(s) of immunization.

Each individual is assigned a unique identification number to allow for longitudinal follow-up to provide comprehensive information about the individual and his/her medical encounters. The MHS is an appropriate data source to evaluate the safety of the Pfizer-BioNTech COVID-19 vaccine, as the vaccine will be distributed through government facilities (including MHS facilities) as part of initial distribution, and analysis of DoD data will provide early data on the safety of the vaccine. The DoD prioritized vaccine distribution to healthcare workers and emergency services personnel, personnel performing activities

090177e1962518d5\Approved\Approved On: 29-Jan-2021 20:00 (GMT)

associated with critical national capabilities, select deploying individuals, other critical and essential support, individuals at the highest risk for developing severe illness from COVID-19, and adults age 75 and older.¹⁶ Specifically, as part of Phase 1a, all healthcare providers, emergency services, and public safety personnel within the DoD population will qualify for the vaccine.⁸ Phase 1b.1 and 1b.2 will include those considered critical for national capabilities and individuals preparing to deploy outside of the US, respectively.⁸

9.5. Study Size

The sample size achieved will depend on the number of individuals administered the Pfizer-BioNTech COVID-19 vaccine within the DoD MHS during the study period, which will increase over time with subsequent analyses. Specifically, the data will be refreshed on a repeated basis, e.g., monthly (to be stipulated in the SAP), and a continuous sequential test procedure will be used to reevaluate data according to this schedule. Preliminary estimates for the number of individuals in the DoD MHS who received the Pfizer-BioNTech COVID-19 vaccine will be reported in the SAP.

As a result of the ability to perform near-real-time analysis, the risk interval (and post-vaccination control interval, for applicable safety events of interest) may have only partially elapsed in some cases. To account for this, we will use methods adopted in previous studies,^{9,28,40} whereby risk intervals will be scaled (or truncated) in order to ensure an equivalent length (or a fixed ratio) of time is assessed between the control and risk intervals. The same approach will also be applied for contemporary unvaccinated controls.

9.5.1. Power

Power calculations for the rapid cycle analysis (RCA) approaches proposed for safety event of interest signal detection will be conducted according to the methods of Kulldorff et al.^{41,42} Table 2 illustrates the estimated power for the RCA approach using the Poisson-based maximized sequential probability ratio test (MaxSPRT), and provides an overview of the power required to detect varying relative risk (RR) estimates with an alpha level of 0.01. T denotes the expected number of safety events of interest to occur during the risk interval of interest (Table 2 and Table 3). Power of $\geq 80\%$ is typically desirable in drug safety research. Usually the FDA views a RR of >3 as meaningful, so this has been to for power calculations here.⁴³ As an example, as shown in Table 2, the surveillance system would have sufficient power (80.0%) to detect an increased risk of safety events of interest associated with the Pfizer-BioNTech COVID-19 vaccine by 3 fold when the expected number of safety events of interest reaches 6 events.

Table 2. Estimated Statistical Power for the Poisson-based MaxSPRT⁴¹

<i>T</i>	True relative risk					
	1.2	1.5	2	3	5	10
0.1	0.013	0.018	0.027	0.049	0.106	0.281
0.2	0.013	0.018	0.029	0.058	0.138	0.401
0.5	0.014	0.023	0.042	0.105	0.299	0.768
1	0.015	0.027	0.059	0.173	0.510	0.957
1.5	0.016	0.032	0.077	0.251	0.693	0.995
2	0.017	0.036	0.097	0.334	0.821	0.9994
2.5	0.018	0.041	0.118	0.415	0.900	0.9999452
3	0.019	0.045	0.139	0.489	0.945	0.9999949
4	0.020	0.053	0.180	0.616	0.984	1
5	0.021	0.061	0.222	0.718	0.996	1
6	0.023	0.070	0.267	0.800	0.9990	1
8	0.025	0.089	0.362	0.909	0.9999529	1
10	0.027	0.110	0.455	0.962	0.9999982	1
12	0.030	0.131	0.542	0.985	0.9999999	1
15	0.033	0.163	0.651	0.996	1	1
20	0.039	0.223	0.795	0.999722	1	1
25	0.045	0.287	0.888	0.99998301	1	1
30	0.051	0.354	0.943	0.99999913	1	1
40	0.064	0.482	0.986	1	1	1
50	0.078	0.597	0.997	1	1	1
60	0.094	0.698	0.99948292	1	1	1
80	0.128	0.843	0.99998632	1	1	1
100	0.164	0.925	0.99999971	1	1	1
120	0.205	0.967	0.99999999	1	1	1
150	0.268	0.991	1	1	1	1
200	0.381	0.9992	1	1	1	1
250	0.491	0.9999445	1	1	1	1
300	0.594	0.99999665	1	1	1	1
400	0.759	0.99999999	1	1	1	1
500	0.868	1	1	1	1	1
600	0.933	1	1	1	1	1
800	0.985	1	1	1	1	1
1,000	0.997	1	1	1	1	1

090177e1962518d5\Approved\Approved On: 29-Jan-2021 20:00 (GMT)

9.6. Data Management

Data for this study will be stored and extracted from the DoD MHS database (previously described in [Section 9.4](#)) that contain information about demographics, vaccinations, procedures, diagnoses, and death.

9.6.1. Case report forms (CRFs)/Electronic data record

As used in this protocol, the term CRF should be understood to refer to either a paper form or an electronic data record or both, depending on the data collection method used in this study.

A CRF is required and should be completed for each included patient in the signal verification phase that requires EMR and chart review (see [Section 9.7.4.3](#)). The completed original CRFs should not be made available in any form to third parties, except for authorized representatives of Pfizer or appropriate regulatory authorities, without written permission from Pfizer. Analysis Group shall ensure that the CRFs are securely stored on DoD servers in an encrypted electronic and/or paper] form and will be password protected or secured in a locked room to prevent access by unauthorized third parties.

Data abstractors have ultimate responsibility for the collection and reporting of all clinical, safety, and laboratory data entered on the CRFs and any other data collection forms (source documents) and ensuring that they are accurate, authentic/original, attributable, complete, consistent, legible, timely (contemporaneous), enduring, and available when required. The CRFs must be signed by the responsible party abstracting medical records and/or adjudicating the endpoints to attest that the data contained on the forms are true and accurate based on their review of the data. Any corrections to entries made in the CRFs or source documents must be dated, initialed, and explained (if necessary) and should not obscure the original entry.

The source documents are the hospital or the physician's chart. In these cases, data collected on the CRFs must match those charts.

9.6.2. Record retention

To enable evaluations and/or inspections/audits from regulatory authorities or Pfizer, Analysis Group agrees to keep all study-related records, which includes study documents and deliverables such as the protocol, SAP, aggregated results tables, SAS programming files, and study report. The records should be retained by Analysis Group according to local regulations or as specified in the vendor contract, whichever is longer. Analysis Group must ensure that the records continue to be stored securely for so long as they are retained.

If Analysis Group becomes unable for any reason to continue to retain study records for the required period, Pfizer should be prospectively notified. The study records must be transferred to a designee acceptable to Pfizer.

Study records must be kept for a minimum of 15 years after completion or discontinuation of the study, unless Analysis Group and Pfizer have expressly agreed to a different period of

retention via a separate written agreement. Record must be retained for longer than 15 years if required by applicable local regulations.

Analysis Group must obtain Pfizer's written permission before disposing of any records, even if retention requirements have been met.

9.7. Data Analysis

Detailed methodology for summary and statistical analyses of data analyzed in this study will be documented in a SAP, which will be dated, filed, and maintained by the sponsor. The SAP may modify the plans outlined in the protocol; any major modifications of primary endpoint definitions or their analyses would be reflected in a protocol amendment. The SAP will also provide additional detail regarding the evaluation of a threshold of excess risk for each of the safety events of interest. Consistent with the approach of Kulldorff et al., this will be determined based on background incidences for each event (e.g., based on historical influenza vaccinated active comparator cohort data to be evaluated during the study), in addition to pre-specified significance level (e.g., $\alpha=0.01$ or 0.05) and power.⁴¹ This information, in conjunction with a clinically meaningful RR (e.g., 2 or 3) and the expected upper limit of events under the null hypothesis will allow for the calculation of critical values of each safety event of interest using the MaxSPRT method. Greater power (e.g., 80%) is also a natural criterion to use when selecting the upper limit on the length of surveillance, and in turn, the expected number of events to occur, although there is ultimately a tradeoff between that power and the time allowed to identify the expected number of events to occur.

Data analyses will be conducted using SAS Enterprise Guide version 7.1 (SAS Institute Inc., Cary, NC) or R Version 3.5.3 or its latest version (R Core Team, Vienna, Austria). In addition, SaTScan will also be used to conduct specific temporal analyses.

9.7.1. Identification of Contemporary Unvaccinated Controls

Exact and PS matching will be used to identify contemporary unvaccinated controls with similar baseline characteristics to individuals who receive Pfizer-BioNTech COVID-19 vaccine. The PS will be defined as the probability of receiving the Pfizer-BioNTech COVID-19 vaccine versus not receiving the vaccine conditional on observed baseline characteristics. The PS model will be estimated using logistic regression, by regressing receipt of vaccine on baseline covariates. In this way, both exact and PS matching will be used to balance the distribution of observed baseline covariates between vaccinated and unvaccinated individuals, with exact matching used specifically for the most important prognostic factors. A matching ratio of 1:N, but no greater than 1:4 will be used due to diminishing gains in efficiency with higher ratios.²⁴ The exact matching ratio will be determined pending the available sample size of contemporary unvaccinated controls. A balanced nearest neighbor matching approach (with a caliper) will be used in order to require that controls alternate between having PS great than and less than the matched vaccinated individual in order to avoid contemporary unvaccinated controls being consistently clustered to one side of the matched vaccinated individual.⁴⁴ This approach has been shown to result in lower bias than the more commonly used greedy matching approach. If a sufficient number of controls cannot be obtained by matching on these covariates, then a variable matching ratio will be

considered, the most important confounders will be chosen for matching, and the number of matching covariates may be reduced in order to ensure sufficient sample size can be obtained for the study.

9.7.2. Baseline Characteristics

Baseline demographics and clinical characteristics for individuals receiving Pfizer-BioNTech COVID-19 vaccine, individuals who received seasonal influenza vaccination, and contemporary unvaccinated controls will be summarized using descriptive statistics, consisting of the mean and standard deviation (SD) and median (interquartile range [IQR]) values for continuous variables and frequency distributions for categorical variables. Incidence rates (i.e., per-patient per-month) for prior hospitalizations may be calculated as the number of events divided by person-time of observation since the length of the baseline period may vary between individuals. Standardized differences will be calculated between individuals who received the Pfizer BioNTech COVID-19 vaccine and with active comparators who received seasonal influenza vaccination. In addition, standardized differences will be calculated between contemporary unvaccinated controls and individuals receiving the Pfizer-BioNTech COVID-19 vaccine to ensure that the matched cohorts are similar with respect to the distribution of baseline characteristics. Standardized differences <10% will indicate that matching has appropriately balanced the characteristics between vaccinated and unvaccinated cohorts.

9.7.3. Vaccine Utilization Patterns

Descriptive statistics will also be used to summarize vaccine utilization patterns, including proportion of individuals receiving vaccine, 2-dose completion rate, distribution of time gaps between the first and second dose, and care setting where immunization was received (e.g., outpatient clinic, pharmacy, inpatient ward). Counts of individuals who received a COVID-19 vaccine from a different manufacturer in addition to the Pfizer-BioNTech COVID-19 vaccine will be reported.

9.7.4. Safety Signal Analyses

Several analyses corresponding to the designs discussed previously will be conducted to detect safety signals associated with Pfizer-BioNTech COVID-19 vaccine. Analyses will be conducted among all individuals receiving the vaccine, individuals who received Pfizer-BioNTech COVID-19 vaccine without seasonal flu vaccine (Cohort A will be used for SCRI; Cohort B+C will be used for active comparator analyses), and individuals receiving Pfizer-BioNTech COVID-19 vaccine and seasonal flu vaccine on the same day (Cohort D), along with sub-cohorts receiving only one dose vs. two doses.

A stepwise process, illustrated below, will be performed for signal detection, evaluation, and verification (Figure 3). This approach has been adapted from the Active Monitoring Protocol of the FDA's COVID-19 Vaccine Safety Surveillance Project.¹⁷ The statistical approach described below may be modified further based on data availability, additional clinical input, and for consistency or to complement similar studies of Pfizer-BioNTech COVID-19 vaccine.

Figure 3. Steps in Signal Detection, Evaluation, and Verification

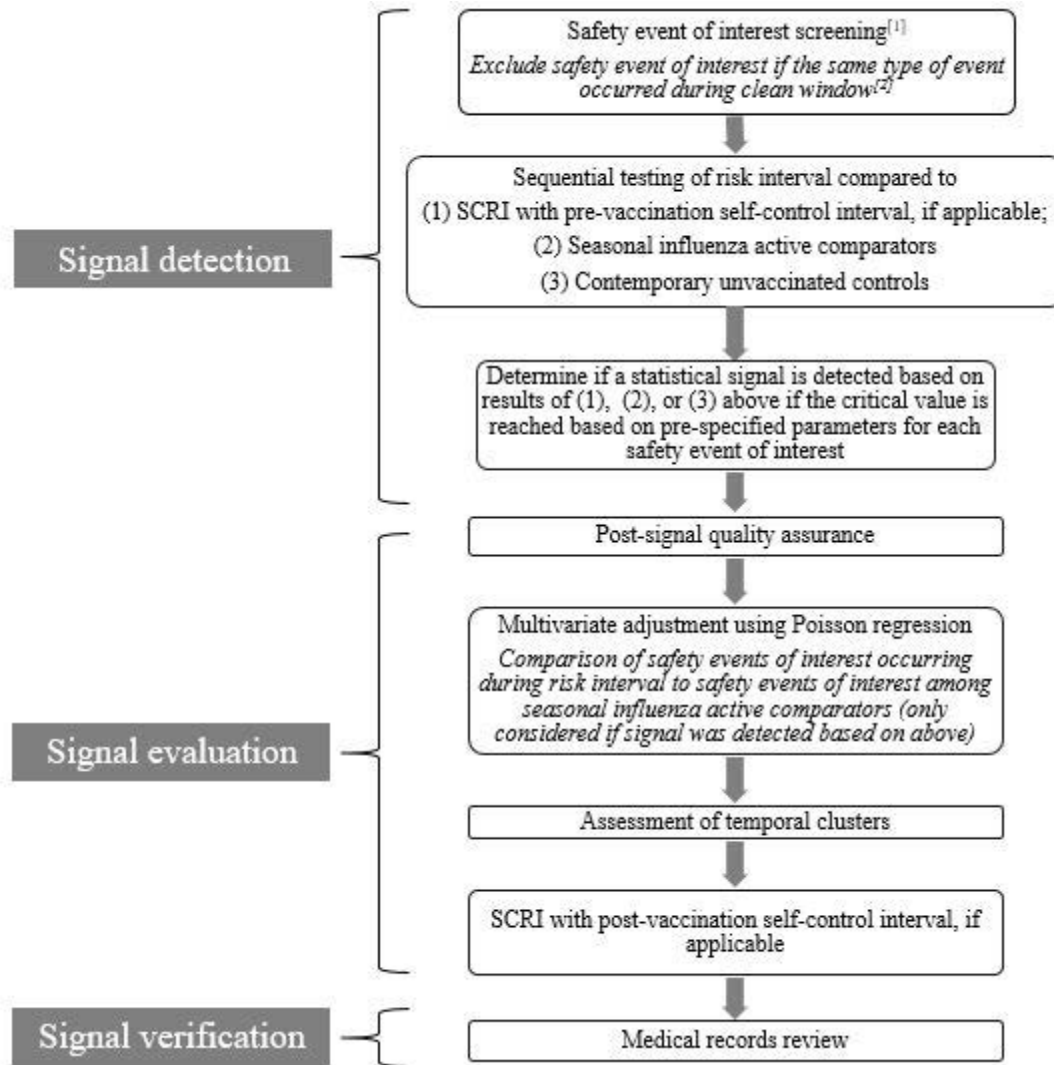

Notes:

[1] List of safety events of interest and corresponding definitions may be refined as the study progresses based on additional available information.

[2] The risk and control intervals selected for the SCRI analysis for each safety event of interest are based on biological plausibility and precedents in the literature. Only the individual's first instance during the specified clean window (i.e., the interval used to define incident outcomes) will be included. Note that only the first inpatient or outpatient occurrence of a safety event of interest following the clean window will be used to identify incident events (e.g., if an inpatient safety event of interest occurs in the clean window, a repeat occurrence will not be counted in the risk interval). However, event worsening will be counted as a safety event of interest. For example, if an outpatient safety event of interest occurs in the clean window and an inpatient occurrence for the same type of safety event of interest occurs in the risk interval, the inpatient occurrence will be counted as a safety event of interest.

9.7.4.1. Signal Detection

9.7.4.1.1. Sequential Testing - SCRI Design using the Binomial-based MaxSPRT for Comparison to Pre-vaccination Control Intervals

The goal is to provide rapid-cycle, near real-time safety surveillance. In the signal detection phase, the SCRI analysis will only include pre-vaccination control intervals as the post-

090177e1962518d5\Approved\Approved On: 29-Jan-2021 20:00 (GMT)

vaccination control intervals will require a longer time to accumulate and thus will not allow for timely analysis. The post-vaccination control period will be assessed during the signal evaluation phase (see Section 9.7.4.2), to allow for additional observation time to accrue as well as to more deeply investigate potential signals. This will allow for timely RCA without the need to wait for data to accumulate for safety events of interest with post-vaccination control intervals.

To account for multiple testing and repeated review of the data, e.g., monthly (to be stipulated in the SAP), the MaxSPRT using a binomial probability model will be applied. The null hypothesis (H_0) assumes that the risk of a safety event of interest during the risk interval is equivalent to the risk of the same safety event of interest developing during the control interval, accounting for differences in interval duration as needed (e.g., for safety events of interest such as demyelinating disease), meaning a RR of 1 is specified under H_0 .²⁵ The one-sided composite alternative hypothesis (H_a) assumes that the risk of a safety event of interest during the risk interval is greater than the risk of the same safety event of interest developing during the control interval, accounting for differences in interval duration (i.e., $RR > 1$, H_a is applicable across a range of RRs).⁴¹

Specifically, for the Pfizer-BioNTech COVID-19 vaccine, let x represent the total count of safety events of interest in the control interval (Figure 4), let y represent the total count of safety events of interest in the risk interval, and let r represent the ratio of y to x under the null hypothesis. Thus, when the total control interval duration and total risk interval duration are equal, r will be 1. The RR is estimated by $\frac{y}{x}$.²⁸ The RR and corresponding 99% confidence intervals (CIs) will be calculated.

Figure 4. Example of SCRI Design for a Safety Event of Interest with a 42-day Risk Interval and a Pre-vaccination Control Interval

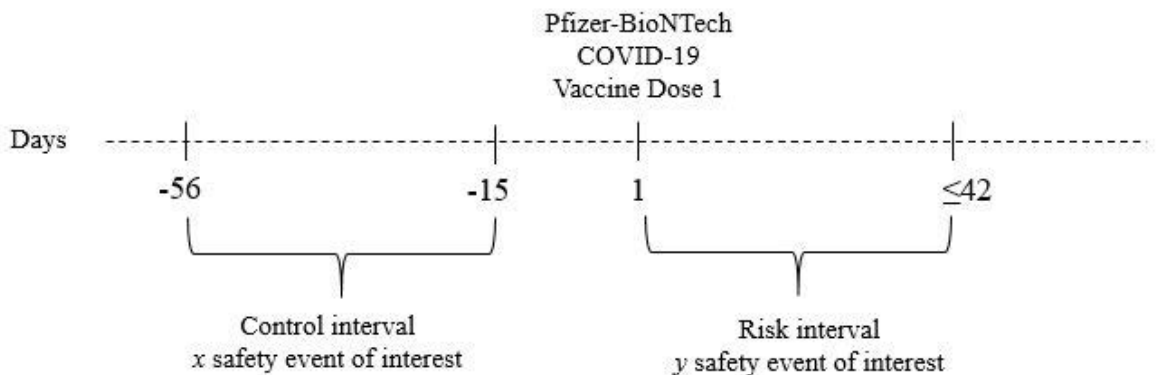

For the binomial model, the log-likelihood ratio (LLR) is calculated as the log probability of observing this distribution of y under H_a , divided by the probability of this occurring under H_0 .⁴¹ This ratio is calculated whenever new data are received to account for the continuous data stream until the full 42-day risk period is complete.

090177e1962518d5\Approved\Approved On: 29-Jan-2021 20:00 (GMT)

$$LLR = \ln \frac{P(y | H_a)}{P(y | H_0)}$$

Once the LLR test statistic reaches a pre-specified critical value, a signal is detected. Specifically, the null hypothesis will be rejected if the LLR exceeds the critical value. The null hypothesis will not be rejected if the LLR does not reach or exceed the critical value, if the total number of safety events of interest reaches a pre-specified upper limit, or if surveillance ends without reaching this upper limit.²⁸

For each safety event of interest (and specific to each age group, if age-stratified analyses are conducted), the critical value of the LLR will be determined based on the safety event of interest-specific upper limit of expected safety events of interest and alpha level.²⁸ Upper limits will be determined based on the expected number of safety events of interest under the null hypothesis, assuming the risk after Pfizer-BioNTech COVID-19 vaccination is no greater than the risk of safety events of interest after seasonal influenza vaccination. Therefore, upper limits will be chosen such that they would not usually be reached.

9.7.4.1.2. Sequential Testing - Poisson-based MaxSPRT for Comparison to Active Comparators who Received Seasonal Influenza Vaccination

For comparison with active comparators who received seasonal influenza vaccination, the Poisson-based MaxSPRT will be applied, following the same statistical approach as described above, but using a Poisson probability distribution. In the Poisson MaxSPRT approach, the event frequency of safety events of interest in the risk interval after Pfizer-BioNTech COVID-19 vaccination will be compared to a background rate of safety events of interest in the risk interval after seasonal influenza vaccination in five prior seasons, ranging from 2014/15 through 2018/19. This approach is particularly important for extremely rare safety events of interest (i.e., less than 50 anticipated based on historical influenza vaccine safety events of interest rates).²⁵ Poisson MaxSPRT is used to monitor very rare safety events of interest as binomial MaxSPRT may not detect a signal, despite a clinically meaningful RR.²⁸ This will also allow for more timely analysis using historical data, as well as improved power and sample size.

GBS is of particular interest relative to the safety profile of Pfizer-BioNTech COVID-19 vaccine. As GBS is an extremely rare safety event of interest, the primary RCA proposed will focus on Poisson MaxSPRT and apply an alpha of 0.05. The Poisson MaxSPRT has increased power to detect a signal with fewer occurrences of the safety event of interest. However, this method cannot fully control for confounding by indication.

9.7.4.1.3. Sequential Testing - Binomial-based MaxSPRT or conditional Poisson MaxSPRT for Comparison to Contemporary Unvaccinated Controls

For comparison with the contemporary unvaccinated controls, the binomial-based MaxSPRT will be applied, following the same statistical approach as described above. Data during the risk intervals of vaccinated individuals and contemporary unvaccinated controls will accumulate at the same time, and thus follow-up for both cohorts are expected to be comparable.

Over time, however, the number of eligible contemporary unvaccinated controls to be matched to vaccinated individuals is expected to decrease, which will result in uncertainty in the expected number of safety events of interest.⁴⁵ As a result, conditional Poisson MaxSPRT (CMaxSPRT) may be considered to account for error in the estimated expected number of safety events of interest and to consider historical data on contemporary unvaccinated controls, as it will not require a baseline risk function and is more appropriate when the expected number of cases in the comparative data are small in order to reduce bias toward signaling.⁴⁶ The feasibility of continued matched contemporary unvaccinated control analysis will be reassessed if sufficient matches cannot be identified in the data.

9.7.4.1.4. Critical Values and Alpha Spending

Critical values for the LLR test statistic are shown below in [Table 3](#) based on calculations conducted by Kulldorff et al. 2011.⁴¹ For example, assuming $T=6$ (number of expected events under the null) and $RR=3$, which corresponds to a power of 80.0% (See [Section 9.5.1](#)), the critical value would be 5.14 using alpha of 0.01 for the Poisson-based MaxSPRT. As noted previously, each safety event of interest will be evaluated separately to determine a critical value based on background incidence, alpha, power, and clinically meaningful RR. These details will be addressed in the SAP.

Table 3. Critical Values for Poisson-based MaxSPRT

T	$\alpha = 0.05$	$\alpha = 0.01$	$\alpha = 0.001$
0.1	2.044069	4.119293	6.579669
0.2	2.266893	4.179630	6.754862
0.5	2.637928	4.483740	7.034472
1	2.853937	4.670428	7.172614
1.5	2.964971	4.778944	7.278202
2	3.046977	4.862223	7.341453
2.5	3.110419	4.924475	7.397851
3	3.162106	4.971792	7.445736
4	3.245004	5.040311	7.518319
5	3.297183	5.091907	7.569312
6	3.342729	5.136461	7.608607
8	3.413782	5.206326	7.673013
10	3.467952	5.260513	7.724863
12	3.511749	5.302914	7.767520
15	3.562591	5.351279	7.814719
20	3.628123	5.414770	7.877573
25	3.676320	5.463382	7.924478
30	3.715764	5.502563	7.962688
40	3.774663	5.561620	8.022182
50	3.819903	5.605972	8.067072
60	3.855755	5.642209	8.102340
80	3.910853	5.697631	8.157530
100	3.952321	5.738974	8.199403
120	3.985577	5.772435	8.232827
150	4.025338	5.812121	8.272692
200	4.074828	5.862113	8.322983
250	4.112234	5.899824	8.360938
300	4.142134	5.929897	8.391288
400	4.188031	5.976241	8.438008
500	4.222632	6.011088	8.473183
600	4.250310	6.039013	8.501314
800	4.292829	6.081871	8.544590
1,000	4.324917	6.114225	8.577253

Multiple types of alpha spending functions can be employed to calculate the cumulative rate at which Type 1 error (alpha) probability is spent during sequential testing.⁴⁷ To achieve optimal expected time-to-signal, especially when historical Poisson data are used with surveillance data, a power-type convex alpha spending shape will be used based on published literature.⁴⁷ Additionally, $\rho = 1.5$ is referenced as a “rule of thumb” as it is suggested to be appropriate in most applications.

9.7.4.2. Signal Evaluation

Signals are detected when the event frequency of a safety event of interest during the risk interval following vaccination with Pfizer-BioNTech COVID-19 vaccine is significantly increased compared to the event frequency of the same safety event of interest in the control

090177e1962518d5\Approved\Approved On: 29-Jan-2021 20:00 (GMT)

comparator (i.e., the critical value is achieved and surpassed). If signals are indeed detected for safety events of interest based on the analysis described above, further evaluation is warranted to refine and confirm such signals. This will include the following additional analyses to assess the robustness of the findings.

9.7.4.2.1. Post-Signal Quality Assurance

Quality assurance will first be conducted in order to assess the quality of the data and analysis that produced the signal. While quality control measures will be conducted during the signal detection phase (see [Section 9.8](#)), post-signal quality assurance will also be performed. This will include a comprehensive quality assurance (for example, check for possible duplications of claims or medical records, checking for unusual clustering in claim or medical record accrual by service date for potential coding issues, check for geographical distribution of cases that may be related to lot numbers or diagnostic practice). In addition, for signals detected via active comparison, additional analyses comparing to pre-vaccination control intervals may be formed to check for consistency. Signals will also be confirmed across all of the safety studies planned to be performed (i.e., C4591008, C4591011, C4591012) to confirm that specific data sources are not biased.

9.7.4.2.2. Multivariate Adjustment using Poisson Regression

If signals are detected and persist after conducting quality assurance, further evaluation via statistical measures are warranted. Specifically, to investigate whether potential signals identified via Poisson MaxSPRT for the comparison to active comparators with seasonal influenza vaccination are not confounded (i.e., to take into account baseline differences between the Pfizer BioNTech COVID-19 vaccinated and active comparator populations), a multivariate Poisson regression analysis will be conducted to compare the incidence rates of the safety events of interest occurring within the risk intervals. The predictor would be whether the individual had received the Pfizer-BioNTech COVID-19 vaccine or had received the influenza vaccine during historical seasons. Analyses will be adjusted for relevant baseline and/or clinical characteristics (e.g., age, sex, race, CCI and/or specific comorbidities of interest, state, etc.).⁹

If the signal remains, based on an IRR >3 with a p-value <0.01 from the adjusted Poisson regression, further evaluation may be considered via signal verification.

9.7.4.2.3. Assessment of Temporal Clusters

Vaccine safety surveillance must allow for sufficient type I error probability for rapid signal detection, and statistically significant signals must be studied further to ensure that a true association is present.⁴⁸ Therefore, the presence of temporal clusters will be assessed using the software SaTScan to calculate temporal scan statistic in order to further refine safety signals detected from the signal detection analyses.²⁵ A temporal scan statistic accounts for multiple testing present during overlapping risk intervals. The null hypothesis assumes that there is no association between the safety event of interest and immunization, and safety events of interest are assumed to be distributed independently and uniformly during a period of time subsequent to Pfizer-BioNTech COVID-19 vaccination.²⁵ A temporal scan statistic will be generated by moving a time interval of fixed length across the risk interval,

comparing the number of observed versus expected safety events of interest within the time interval under the null hypothesis.⁴⁹

9.7.4.2.4. Sequential Testing - SCRI Design using the Binomial MaxSPRT for Comparison with Post-Vaccination Control Intervals

Similar to the SCRI design using the binomial-based MaxSPRT method for pre-vaccination control intervals, sequential testing analyses will be conducted using the post-vaccination control intervals as appropriate for specific safety events of interest. This will be conducted during the signal evaluation phase in order to allow time to accumulate during the post-vaccination control period. The same statistical methodology as described for the pre-vaccination control intervals will be applied.

9.7.4.3. Signal Verification

If a signal persists after conducting signal evaluation, signal verification through medical records review may be conducted.

9.7.4.3.1. Medical Records Review

As part of the signal evaluation process, diagnostic validation of the detected safety events of interest (i.e., cases) via adjudication of medical records by DoD MHS clinicians for outcome verification will be conducted in a representative sample of cases. The total number of charts to be reviewed will depend on the number of safety events of interest detected, such that all cases may be reviewed for safety events of interest where a small number of events result in signal detection and a representative sub-sample may be reviewed for safety events of interest where a larger number of events results in signal detection.⁵⁰ For rare events, potentially all cases may be adjudicated. An adjudication charter will be developed to govern signal evaluation and medical records review. Specifically, validation of detected safety events of interest will be performed through patient medical chart review in collaboration with an adjudication committee comprised of the treating or trained healthcare professionals.⁵⁰

9.7.5. Seasonality-Adjusted Cases-Centered Method

A case-centered analysis for specific safety events of interest for which signals were detected may also be conducted in order to account for bias caused by seasonality of safety events of interest and vaccination.²⁶ This method will use data on all safety event of interest cases that occur after vaccination with Pfizer-BioNTech COVID-19 vaccine. Logistic regression will be used to compare the number of safety event of interest cases that were vaccinated inside versus outside a pre-specified risk interval, as of the date of the safety events of interest, where the total number of vaccinations given inside versus outside the risk interval (in the population of all vaccinees) is used as the offset term.²⁸ Specifically, the association of vaccination with risk of safety events of interest will be estimated from a logistic regression model that includes summarized data with one record per risk set. The key independent variable will be the proportion of the risk set who were in the risk interval on the date of the safety event of interest occurrence. In this way, risk sets are anchored to calendar dates, and confounding by seasonality of the safety events of interest and vaccination is addressed.⁵¹

090177e1962518d5\Approved\Approved On: 29-Jan-2021 20:00 (GMT)

Note that other confounders may also be adjusted for by restricting risk sets to vaccinees similar with respect to select characteristics (i.e., through stratification).

9.7.6. End-of-Season and End-of-Surveillance Analyses

For any safety event of interest with signals detected, end-of-season analyses (over the course of the 30-month period) and an end-of-surveillance analysis (i.e., at 30 months) will be conducted. Similar methodology will be applied for the end-of-surveillance analysis and end-of-season analysis conducted for seasonal influenza vaccine and contemporary unvaccinated controls, respectively, in order to adjust for the seasonality of both disease and vaccine administration.⁹ This approach will be able to define the true risk intervals after each dose and estimate the risk for potential safety events of interest after both dose 1 and 2 of the Pfizer-BioNTech COVID-19 vaccine, as well as the ability to discern whether or not one or two doses of seasonal influenza vaccine were administered during the same period.

The number of events in the sum of three distinct risk intervals will be compared to the control interval, adjusting for potential differences in interval length, to estimate the RR of Pfizer-BioNTech COVID-19 vaccine compared to the influenza vaccine. In order to monitor the safety after the first and full course of the vaccine, the number of potential safety events of interest occurring in three separate risk intervals (P_1 , P_2 , P_3) will be estimated (Figure 5). P_1 represents the risk interval after the first dose only, excluding any overlap in risk intervals with the second dose. P_2 represents the overlapping risk intervals for first and second dose of the vaccine. P_3 represents the risk interval of the second dose of the vaccine, excluding the overlapping risk interval already captured in P_2 . This design will allow for the assessment of risk during the appropriate periods, regardless of the time interval between vaccine doses. As multiple endpoints will be assessed, 99% CIs will be calculated around the RR in order to ascertain whether the Pfizer-BioNTech COVID-19 vaccine is associated with safety events of interest.

Figure 5. Example of Risk (P1, P2, P3) and Pre-vaccination Control Intervals for the SCRI End-of-surveillance Analyses of 1 or 2 Doses of Pfizer-BioNTech COVID-19 Vaccine

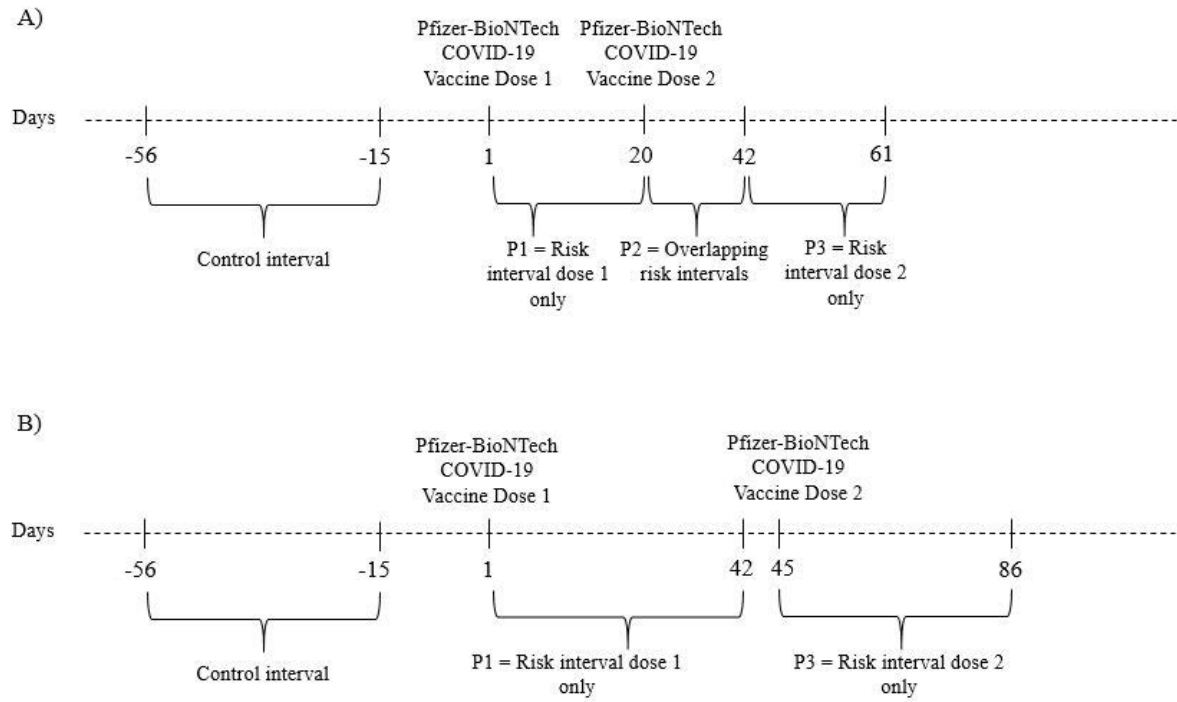

In **Figure 5A**, $P_1 + P_2 + P_3$ represent the risk intervals where a safety event of interest may occur. In **Figure 5B**, there is no overlapping risk interval so that $P_1 + P_3$ represent the risk intervals where a safety event of interest may occur. The timing of the risk and control intervals may be adjusted for in order to control for the effect of seasonality across the intervals assessed.

9.7.7. Subgroup Analysis

Separate analyses of baseline characteristics, vaccine utilization patterns, signal detection, signal evaluation, and signal verification in subgroups of interest may be conducted based on feasibility, sample size, and data available.

9.7.8. Incidence Rates and Time to Safety Event of Interest Analysis

Incidence rates (and corresponding CIs) will be calculated from safety event of interest signal detection analyses. Kaplan-Meier methods will be used to analyze time-to-event (i.e., time to safety event of interest). If individuals do not experience the safety event of interest, they will be censored at the end of the risk interval. Median time to safety event of interest and corresponding CIs will be reported.

090177e1962518d5\Approved\Approved On: 29-Jan-2021 20:00 (GMT)

9.8. Quality Control

DoD data will be accessed through a secured server using encrypted login and passwords. Access to de-identified DoD data will be by HealthResearchTx (HRTx) through HRTx's secure private cloud computing environment.

Each data content area will be subject to high level variable name/type checks, to detailed trending comparisons. As an example, the diagnostic data is subject to the following checks:

- Referenced table exists
- Diagnosis type is correctly assigned by codes defining the diagnosis
- Percentages, rates, are as expected (check ranges and for missing)
- Both inpatient and outpatient diagnosis codes are captured. Referenced variables exist and are of appropriate length and type

Data retrieval will be coordinated by an experienced programmer/analyst. The analyst will write programming for retrieval of each data element from the electronic databases. Double programming will be performed for the first iteration of the analyses; results/datasets will be compared, and if any discrepancies are identified, both programmers will determine a resolution, bringing in a third programmer if needed. Subsequent iterations of analyses (i.e., re-runs of the analyses) will be audited by a senior programmer. All tables will be reviewed by the project manager and the principal investigator to evaluate for internal consistency of counts and totals. All calculated variables will be checked against the component variables (cross tabs) to ensure accuracy. For example, categorical age would be compared with continuous age to confirm that each category of age contained only individuals of the expected age ranges within that category.

9.9. Strengths and Limitations of the Research Methods

To identify individuals who experienced safety events of interest associated with Pfizer-BioNTech COVID-19 vaccine, the SCRI method of signal detection offers some key advantages. The SCRI approach inherently adjusts for within-individual confounders, such as age, sex, and confounding by indication or contraindication. Additionally, the inclusion of a post-vaccination control period and comparison to unvaccinated controls will account for increased detection bias from stimulated safety event of interest reporting due to heightened vigilance on COVID-19 vaccines.⁵² Specifically, safety events of interest may be more likely to be reported or sought care for after vaccination with Pfizer-BioNTech COVID-19 vaccine than before (i.e., during the pre-vaccination control interval) which may result in bias against the Pfizer-BioNTech COVID-19 vaccine. Exact and PS matching will also be implemented for contemporary unvaccinated controls in order to ensure that baseline characteristics between Pfizer-BioNTech COVID-19 vaccinees and contemporary unvaccinated controls are comparable. Lastly, SCRI allows for near real-time monitoring of safety risks associated with the Pfizer-BioNTech COVID-19 vaccine.

The DoD operates the largest cradle-to-grave healthcare database in the US. This data is both geographically and demographically representative of the US general population.¹⁵ The DoD also provides comprehensive access to its covered beneficiaries, which allows prescriptions to be obtained at either no or low cost. In addition, as all DoD beneficiaries are eligible for healthcare coverage across locations of care, past studies have shown loss to follow-up to be minimized.⁵³ The DoD MHS database provides a range of additional benefits, including its comprehensive structure, large number of enrollees, and electronic accessibility. The DoD MHS database also comprises of EMR data and allows for the possibility of chart review. Importantly, the DoD MHS database retains electronic immunization records that include manufacturer name and lot numbers, facilitating the identification of brand-specific vaccines, such as the Pfizer-BioNTech COVID-19 vaccine. Moreover, the DoD data are updated frequently, which will allow for rapid monitoring of potential safety signals on a repeated basis, e.g., monthly (to be stipulated in the SAP).

However, there are several limitations when relying on secondary data sources such as the DoD MHS database that should be noted. First, EMR data (such as laboratory and diagnostic test results) will not be available for all individuals in the DoD MHS (i.e., purchased care only enrollees). As such, outcomes among these individuals will be identified via administrative claims data, which may be subject to the misspecification of billing codes or lack of documentation that may result in potential misclassification. Second, contemporary unvaccinated controls may be systematically different from individuals receiving Pfizer-BioNTech COVID-19 vaccine. While a matched based approach will be performed to increase the comparability between cohorts, caution should be exercised when interpreting the results of real-world studies due to the potential bias from unmeasured or residual confounding. Third, patients who may have dual coverage through TRICARE or DoD and through Medicare may not be captured in the MHS healthcare database since their vaccinations may be covered through Medicare. For instance, for patients with Medicare Part B, TRICARE may serve as a second payer to Medicare. Therefore, if there is no cost share for a service (such as vaccination) for a Medicare beneficiary provided outside of the DoD MHS, then there will be no evidence of that healthcare encounter within the MHS. This may particularly be an issue for misclassification of receipt of seasonal influenza vaccine and similarly, for the COVID-19 vaccine, since Medicare covers flu shots at 100% without any further cost share, and there will be no TRICARE claim. As such, some patients who appear not to have received seasonal influenza vaccine may have indeed received the influenza vaccine. This limitation will be addressed by conducting stratified analyses within specific age groups that exclude Medicare beneficiaries.

9.10. Other Aspects

Not applicable.

10. PROTECTION OF HUMAN SUBJECTS

10.1. Patient Information

All parties will comply with all applicable laws, including laws regarding the implementation of organizational and technical measures to ensure protection of patient personal data. Such

measures will include omitting patient names or other directly identifiable data in any reports, publications, or other disclosures, except where required by applicable laws.

To protect the rights and freedoms of natural individuals with regard to the processing of personal data, when study data are compiled for transfer to Pfizer and other authorized parties, any patient names will be removed and will be replaced by a single, specific, numerical code. All other identifiable data transferred to Pfizer or other authorized parties will be identified by this single, patient-specific code. In case of data transfer, Pfizer will maintain high standards of confidentiality and protection of individuals' personal data consistent with the vendor contract, and applicable privacy laws.

10.2. Patient Consent

As this study does not involve data subject to privacy laws according to applicable legal requirements, obtaining informed consent from individuals by Pfizer is not required.

10.3. Institutional Review board (IRB)/Independent Ethics Committee (IEC)

There must be prospective approval of the study protocol, protocol amendments, and their relevant documents from the relevant IRBs/IECs. All correspondence with the IRB/IEC must be retained. Copies of IRB/IEC approvals must be forwarded to Pfizer. The study protocol will be reviewed by the US DoD IRB and affiliated privacy board (PB).

10.4. Ethical Conduct of the Study

The study will be conducted in accordance with legal and regulatory requirements, as well as with scientific purpose, value and rigor and follow generally accepted research practices described in Guidelines for Good Pharmacoepidemiology Practices (GPP) issued by the International Society for Pharmacoepidemiology,⁵⁴ the FDA Guidance for Industry and FDA Staff: Best Practices for Conducting and Reporting, Pharmacoepidemiologic Safety Studies Using Electronic Healthcare Data⁵⁵ and Good Epidemiological Practice (GEP) guidelines issued by the International Epidemiological Association (IEA).⁵⁶

11. MANAGEMENT AND REPORTING OF ADVERSE EVENTS/ADVERSE REACTIONS

Signal Detection and Evaluation

This study involves data that exist as structured data by the time of study start or a combination of existing structured data and unstructured data, which will be converted to structured form during the implementation of the protocol solely by a computer using automated/algorithmic methods, such as natural language processing. In these data sources, individual patient data are not retrieved or validated, and it is not possible to link (i.e., identify a potential association between) a particular product and medical event for any individual. Thus, the minimum criteria for reporting an adverse event (AE) (i.e., identifiable patient, identifiable reporter, a suspect product, and event) cannot be met.

Signal Verification

This study protocol requires human review of patient-level unstructured data; unstructured data refer to verbatim medical data, including text-based descriptions and visual depictions

of medical information, such as medical records, images of physician notes, neurological scans, X-rays, or narrative fields in a database. The reviewer is obligated to report adverse events (AEs) with explicit attribution to any Pfizer drug that appear in the reviewed information (defined per the patient population and study period specified in the protocol). Explicit attribution is not inferred by a temporal relationship between drug administration and an AE, but must be based on a definite statement of causality by a healthcare provider linking drug administration to the AE.

The requirements for reporting safety events of interest on the non-interventional study (NIS) adverse event monitoring (AEM) Report Form to Pfizer Safety are as follows:

- All serious and non-serious AEs with explicit attribution to any Pfizer drug that appear in the reviewed information must be recorded on the data collection tool (e.g., chart abstraction form) and reported, within 24 hours of awareness, to Pfizer Safety using the NIS AEM Report Form.
- Scenarios involving drug exposure, including exposure during pregnancy, exposure during breast feeding, medication error, overdose, misuse, extravasation, lack of efficacy, and occupational exposure associated with the use of a Pfizer product must be reported, within 24 hours of awareness, to Pfizer Safety using the NIS AEM Report Form.

For these AEs with an explicit attribution or scenarios involving exposure to a Pfizer product, the safety information identified in the unstructured data reviewed is captured in the Event Narrative section of the report form, and constitutes all clinical information known regarding these AEs. No follow-up on related AEs will be conducted.

All the demographic fields on the NIS AEM Report Form may not necessarily be completed, as the form designates, since not all elements will be available due to privacy concerns with the use of secondary data sources. While not all demographic fields will be completed, at the very least, at least one patient identifier (e.g., gender, age as captured in the narrative field of the form) will be reported on the NIS AEM Report Form, thus allowing the report to be considered a valid one in accordance with pharmacovigilance legislation. All identifiers will be limited to generalities, such as the statement “A 35-year-old female...” or “An elderly male...” Other identifiers will have been removed.

Additionally, the onset/start dates and stop dates for “Illness”, “Study Drug”, and “Drug Name” may be documented in month/year (mm/yyyy) format rather than identifying the actual date of occurrence within the month /year of occurrence in the day/month/year (DD/MMM/YYYY) format.

All research staff members must complete the following Pfizer training requirements:

- Your Reporting Responsibilities (YRR) Training for Vendors Working on Pfizer Studies.

These trainings must be completed by research staff members prior to the start of data collection. All trainings include a “Confirmation of Training Certificate” (for signature by the trainee) as a record of completion of the training, which must be kept in a retrievable format. Copies of all signed training certificates must be provided to Pfizer.

Re-training must be completed on an annual basis using the most current Your Reporting Responsibilities training materials.

12. PLANS FOR DISSEMINATING AND COMMUNICATING STUDY RESULTS

This protocol will be posted on publicly available registers following its finalization. The final study results will be made publicly available via the European Union Post Authorisation Safety (EU PAS) Register and may be submitted for publication in a peer reviewed medical journal.

In the event of any prohibition or restriction imposed (e.g., clinical hold) by an applicable competent authority in any area of the world, or if the investigator is aware of any new information which might influence the evaluation of the benefits and risks of a Pfizer product, Pfizer should be informed immediately.

13. REFERENCES

1. World Health Organization (WHO). WHO Director-General's opening remarks at the media briefing on COVID-19 -11 March 2020. <https://www.who.int/dg/speeches/detail/who-director-general-s-opening-remarks-at-the-media-briefing-on-covid-19---11-march-2020>. Accessed November 11, 2020.
2. Johns Hopkins University. Coronavirus Resource Center. <https://coronavirus.jhu.edu/>. Accessed November 10, 2020.
3. U.S. Food and Drug Administration (FDA). Vaccines and Related Biological Products Advisory Committee Meeting: FDA Briefing Document Pfizer-BioNTech COVID-19 Vaccine. In:December 10, 2020.
4. U.S. Food & Drug Administration (FDA). Pfizer COVID-19 Vaccine EUA Letter of Authorization reissued 12-23-20. In:December 23, 2020.
5. U.S. Food and Drug Administration (FDA). FDA Takes Key Action in Fight Against COVID-19 By Issuing Emergency Use Authorization for First COVID-19 Vaccine. <https://www.fda.gov/news-events/press-announcements/fda-takes-key-action-fight-against-covid-19-issuing-emergency-use-authorization-first-covid-19>.
6. Pfizer Inc. Pfizer and BioNTech Achieve First Authorization in the World for a Vaccine to Combat COVID-19. <https://www.pfizer.com/news/press-release/press-release-detail/pfizer-and-biontech-achieve-first-authorization-world>. Accessed January 4, 2021.
7. Pfizer Inc. Pfizer and BioNTech Receive Authorization in the European Union for COVID-19 Vaccine. <https://www.pfizer.com/news/press-release/press-release-detail/pfizer-and-biontech-receive-authorization-european-union>. Accessed December 28, 2020.
8. U.S. Department of Defense. DoD Population Schema. 2020.
9. Yih WK, Lee GM, Lieu TA, et al. Surveillance for adverse events following receipt of pandemic 2009 H1N1 vaccine in the Post-Licensure Rapid Immunization Safety Monitoring (PRISM) System, 2009-2010. *Am J Epidemiol.* 2012;175(11):1120-1128.
10. American Medical Association (AMA). Appendix Q: Severe Acute Respiratory Syndrome Coronavirus 2 (SARS-CoV-2) (coronavirus disease [COVID-19]) Vaccines. <https://www.ama-assn.org/system/files/2020-11/covid-19-immunizations-appendix-q-table.pdf>. Accessed January 12, 2021.
11. Centers for Medicare & Medicaid Services. COVID-19 Vaccines and Monoclonal Antibodies. 2020; <https://www.cms.gov/medicare/medicare-part-b-drug-average-sales-price/covid-19-vaccines-and-monoclonal-antibodies>. Accessed January 14, 2021.
12. Center for Disease Control (CDC). People with Certain Medical Conditions. December 29, 2020; <https://www.cdc.gov/coronavirus/2019-ncov/need-extra-precautions/people-with-medical-conditions.html>. Accessed January 4, 2021.
13. Military Health System. About the Military Health System. 2021; <https://www.health.mil/About-MHS>. Accessed Jan 15, 2021, 2021.
14. U.S. Department of Defense Military Health System. Patients by Beneficiary Category. <https://www.health.mil/I-Am-A/Media/Media-Center/Patient-Population-Statistics/Patients-by-Beneficiary-Category>. Accessed January 18, 2021.

15. Dorrance KA, Ramchandani S, Neil N, Fisher H. Leveraging the military health system as a laboratory for health care reform. *Mil Med*. 2013;178(2):142-145.
16. U.S. Department of Defense Military Health System. Getting the COVID-19 Vaccine. 2020; <https://www.health.mil/Military-Health-Topics/Combat-Support/Public-Health/Coronavirus/COVID-19-Vaccine-Efforts/Getting-the-COVID-19-Vaccine>. Accessed January 17, 2021.
17. U.S. Food and Drug Administration (FDA). COVID-19 Vaccine Safety Surveillance Project: Active Monitoring Protocol. December 16, 2020.
18. Center for Disease Control (CDC) COVID-19 Response Team. Preliminary Estimates of the Prevalence of Selected Underlying Health Conditions Among Patients with Coronavirus Disease 2019 — United States, February 12–March 28, 2020. *MMWR Morbidity and Mortality Weekly Report* 2020;69(13):382-386.
19. Gupta S, Hayek SS, Wang W, et al. Factors Associated With Death in Critically Ill Patients With Coronavirus Disease 2019 in the US. *JAMA Intern Med*. 2020;180(11):1-12.
20. Williamson EJ, Walker AJ, Bhaskaran K, et al. Factors associated with COVID-19-related death using OpenSAFELY. *Nature*. 2020;584(7821):430-436.
21. Walsh EE, Frenck RW, Jr., Falsey AR, et al. Safety and Immunogenicity of Two RNA-Based Covid-19 Vaccine Candidates. *N Engl J Med*. 2020.
22. U.S. National Library of Medicine. Study to Describe the Safety, Tolerability, Immunogenicity, and Efficacy of RNA Vaccine Candidates Against COVID-19 in Healthy Individuals. *NCT04368728*.
23. U.S. Food and Drug Administration (FDA) Center for Biologics Evaluation and Research (CBER). Emergency Use Authorization for Vaccines to Prevent COVID-19: Guidance for Industry. <https://www.fda.gov/media/142749/download> Accessed November 10, 2020.
24. U.S. Food and Drug Administration (FDA) Center for Biologics Evaluation and Research (CBER). Development and Licensure of Vaccines to Prevent COVID-19; Guidance for Industry, June 2020. <https://www.fda.gov/media/142749/download>. Accessed November 10, 2020.
25. Lee GM, Greene SK, Weintraub ES, et al. H1N1 and seasonal influenza vaccine safety in the vaccine safety datalink project. *Am J Prev Med*. 2011;41(2):121-128.
26. Fireman B, Lee J, Lewis N, Bembom O, van der Laan M, Baxter R. Influenza vaccination and mortality: differentiating vaccine effects from bias. *Am J Epidemiol*. 2009;170(5):650-656.
27. Virtanen M, Peltola H, Paunio M. Day-to-day reactogenicity and the healthy vaccinee effect of measles-mumps-rubella vaccination. *Pediatrics*. 2000;106(5):E62.
28. Greene SK, Kulldorff M, Yin R, et al. Near real-time vaccine safety surveillance with partially accrued data. *Pharmacoepidemiol Drug Saf*. 2011;20(6):583-590.
29. Keren R, Zaoutis TE, Bridges CB, et al. Neurological and Neuromuscular Disease as a Risk Factor for Respiratory Failure in Children Hospitalized With Influenza Infection. *JAMA*. 2005;294(17):2188-2194.
30. Jewell NP. *Statistics for Epidemiology*. Boca Raton: Chapman & Hall/CRC. Print; 2004.

31. Austin PC. The performance of different propensity-score methods for estimating differences in proportions (risk differences or absolute risk reductions) in observational studies. *Stat Med.* 2010;29(20):2137-2148.
32. Law B, Sturkenboom M. D2.3 Priority List of Adverse Events of Special Interest: COVID-19. 2020.
33. Shimabukuro T. CDC post-authorization/post-licensure safety monitoring of COVID-19 vaccines. *National Center for Immunization & Respiratory Diseases.* 2020.
34. Liu CH, Yeh YC, Huang WT, Chie WC, Chan KA. Assessment of pre-specified adverse events following varicella vaccine: A population-based self-controlled risk interval study. *Vaccine.* 2020;38(11):2495-2502.
35. Baker MA, Baer B, Kulldorff M, et al. Kawasaki disease and 13-valent pneumococcal conjugate vaccination among young children: A self-controlled risk interval and cohort study with null results. *PLoS Med.* 2019;16(7):e1002844.
36. Layton JB, Butler AM, Li D, et al. Prenatal Tdap immunization and risk of maternal and newborn adverse events. *Vaccine.* 2017;35(33):4072-4078.
37. Gee J, Naleway A, Shui I, et al. Monitoring the safety of quadrivalent human papillomavirus vaccine: findings from the Vaccine Safety Datalink. *Vaccine.* 2011;29(46):8279-8284.
38. Wendy Funk, Kennell and Associates. Military Health System Basics. https://www.hsrd.research.va.gov/for_researchers/cyber_seminars/archives/2422-notes.pdf.
39. Defense Health Agency. TRICARE Transformation. August 7, 2020; <https://health.mil/Reference-Center/Presentations/2020/08/07/TRICARE-Brief>. Accessed January 17, 2021.
40. Li R, Stewart B, McNeil MM, et al. Post licensure surveillance of influenza vaccines in the Vaccine Safety Datalink in the 2013-2014 and 2014-2015 seasons. *Pharmacoepidemiol Drug Saf.* 2016;25(8):928-934.
41. Kulldorff M, Davis RL, Kolczak† M, Lewis E, Lieu T, Platt R. A Maximized Sequential Probability Ratio Test for Drug and Vaccine Safety Surveillance. *Sequential Analysis.* 2011;30(1):58-78.
42. Kulldorff M, Silva IR. Continuous Post-Market Sequential Safety Surveillance with Minimum Events to Signal. *arXiv preprint arXiv.* 2015(1503.01978).
43. When Are Risks Real? In. *Clinical Nutrition Insight.* Vol 332007:6.
44. Rassen JA, Shelat AA, Myers J, Glynn RJ, Rothman KJ, Schneeweiss S. One-to-many propensity score matching in cohort studies. *Pharmacoepidemiol Drug Saf.* 2012;21 Suppl 2:69-80.
45. Li L, Kulldorff M. A conditional maximized sequential probability ratio test for pharmacovigilance. *Stat Med.* 2010;29(2):284-295.
46. Yih WK, Kulldorff M, Fireman BH, et al. Active surveillance for adverse events: the experience of the Vaccine Safety Datalink project. *Pediatrics.* 2011;127 Suppl 1:S54-64.
47. Silva IR, Lopes WM, Dias P, Yih WK. Alpha spending for historical versus surveillance Poisson data with CMaxSPRT. *Stat Med.* 2019;38(12):2126-2138.
48. Silva IR. Type I error probability spending for post-market drug and vaccine safety surveillance with binomial data. *Stat Med.* 2018;37(1):107-118.

49. Kulldorff M. A spatial scan statistic. *Communications in Statistics - Theory and Methods*. 2007;26(6):1481-1496.
50. U.S. Food and Drug Administration (FDA) Center for Biologics Evaluation and Research (CBER). Guidance for Industry: Good Pharmacovigilance Practices and Pharmacoepidemiologic Assessment. 2005. Accessed November 12, 2020.
51. Baker MA, Lieu TA, Li L, et al. A vaccine study design selection framework for the postlicensure rapid immunization safety monitoring program. *Am J Epidemiol*. 2015;181(8):608-618.
52. Hoffman KB, Demakas AR, Dimbil M, Tatonetti NP, Erdman CB. Stimulated reporting: the impact of US food and drug administration-issued alerts on the adverse event reporting system (FAERS). *Drug Saf*. 2014;37(11):971-980.
53. M Fox K, v J, Alzola C, Evans A, Tod Morris T. Incidence and Predictors of Pulmonary Events among Patients with Hodgkin Lymphoma Treated with Bleomycin in the US Department of Defense Healthcare System. *Chemotherapy: Open Access*. 2018;07(02).
54. International Society for Pharmacoepidemiology (ISPE). Guidelines for good pharmacoepidemiology practices (GPP). *Pharmacoepidemiol Drug Saf*. 2008;17(2):200-208.
55. U.S. Food and Drug Administration (FDA) Center for Drug Evaluation and Research (CDER). Best Practices for Conducting and Reporting Pharmacoepidemiologic Safety Studies Using Electronic Healthcare Data. 2013; <https://www.fda.gov/media/79922/download>. Accessed January 19, 2021.
56. International Epidemiological Association (IEA). Good Epidemiological Practice (GEP), IEA Guidelines for Proper Conduct of Epidemiological Research. 2007; https://ieaweb.org/IEAWeb/Content/IEA_Publications.aspx. Accessed January 25, 2021.
57. Centers for Medicare & Medicaid Services. 2021 ICD-10-CM Official Guidelines for Coding and Reporting. <https://www.cms.gov/files/document/2021-coding-guidelines-updated-12162020.pdf>. Accessed January 17, 2021.
58. Baxter R, Eaton A, Hansen J, Aukes L, Caspard H, Ambrose CS. Safety of quadrivalent live attenuated influenza vaccine in subjects aged 2-49years. *Vaccine*. 2017;35(9):1254-1258.
59. Johns Hopkins Vasculitis Center. Types of Vasculitis. <https://www.hopkinsvasculitis.org/types-vasculitis/#:~:text=%E2%80%9CAngiitis%E2%80%9D%20and%20%E2%80%9CArteritis%E2%80%9D,lit%20i%20deez%E2%80%9D>. Accessed January 19, 2021.
60. OptumInsight Inc. Guide to Clinical Validation, Documentation and Coding: Acute Kidney Injury. https://www.optum360coding.com/upload/pdf/ECDCG14/CDCG14_v2.pdf. Accessed January 17, 2021.
61. U.S. Department of Health and Human Services. Common Terminology Criteria for Adverse Events (CTCAE). 2017; https://ctep.cancer.gov/protocoldevelopment/electronic_applications/docs/CTCAE_v5_Quick_Reference_5x7.pdf. Accessed January 17, 2021.

62. Forns J, Cainzos-Achirica M, Hellfritzsich M, et al. Validity of ICD-9 and ICD-10 codes used to identify acute liver injury: A study in three European data sources. *Pharmacoepidemiol Drug Saf.* 2019;28(7):965-975.

14. LIST OF TABLES

Table 1.	Outcome algorithms for SCRI analysis, with risk and control intervals.....	39
Table 2.	Estimated Statistical Power for the Poisson-based MaxSPRT ⁴¹	44
Table 3.	Critical Values for Poisson-based MaxSPRT	52
Appendix Table 1.	Demographic and Clinical Characteristics Definitions	67
Appendix Table 2.	Operational Definitions of Safety Events of Interest.....	103

15. LIST OF FIGURES

Figure 1.	Example of SCRI Design for Assessment of a Safety Event of Interest with a 42-day Risk Interval in an Individual who Receives Only One Vaccine Dose, Showing Both Pre- and Post-vaccination Control Intervals	28
Figure 2.	Example of SCRI Design with Overlapping Risk Intervals when Two Doses of Pfizer-BioNTech COVID-19 Vaccine are Administered, Showing a Pre- and Post-vaccination Control Interval	29
Figure 3.	Steps in Signal Detection, Evaluation, and Verification	48
Figure 4.	Example of SCRI Design for a Safety Event of Interest with a 42-day Risk Interval and a Pre-vaccination Control Interval	49
Figure 5.	Example of Risk (P1, P2, P3) and Pre-vaccination Control Intervals for the SCRI End-of-surveillance Analyses of 1 or 2 Doses of Pfizer-BioNTech COVID-19 Vaccine.....	56

16. ANNEX 1. LIST OF STAND-ALONE DOCUMENTS

None.

17. ANNEX 2. ENCEPP CHECKLIST FOR STUDY PROTOCOLS

N/A

18. ANNEX 3. ADDITIONAL INFORMATION

Appendix Table 1. Demographic and Clinical Characteristics Definitions

Variable	Description	Operational definition
Demographic Characteristics		
Age	Continuous variable; <ul style="list-style-type: none"> • Dichotomous variable: 18-64 • ≥ 65; Categorical variable: <ul style="list-style-type: none"> • <35 • 35 - <45 • 45 - <55 • 55 - <65 • 65 - <75 • ≥ 75 	Age as of the date prior to Pfizer-BioNTech COVID-19 vaccination (and/or date prior to seasonal influenza vaccination for active comparators, matched index date for contemporary unvaccinated controls)
Sex	Categorical variable: <ul style="list-style-type: none"> • Male • Female • Unknown 	
State	Geographic regions in the US	State of residence
Sponsor service	Categorical variable: <ul style="list-style-type: none"> • Army • Air Force • Coast Guard • Marine Corps • Navy • Navy Afloat • Other • Unknown 	
Beneficiary category	Categorical variable: <ul style="list-style-type: none"> • Active Duty • Retirees • Active Guard/Reserve • Dependents of Active Duty • Dependents of Retiree 	

090177e1962518d5\Approved\Approved On: 29-Jan-2021 20:00 (GMT)

Appendix Table 1. Demographic and Clinical Characteristics Definitions

Variable	Description	Operational definition
	<ul style="list-style-type: none"> • Dependent Survivor • Dependent of Active Guard/Reserve • Inactive Guard/Reserve • Family Member of Inactive Guard/Reserve • Other • Unknown 	
Clinical Characteristics		
Smoking	Dichotomous variable	Defined by the “tobacco” variable. ‘Y’ indicates the person is a tobacco user ICD-9-CM codes: <ul style="list-style-type: none"> • 305.1, Tobacco use disorder • V15.82, History of tobacco use ICD-10-CM codes: <ul style="list-style-type: none"> • F17.200, Nicotine dependence, unspecified, uncomplicated • Z7.20, Tobacco use • Z87.891, Personal history of nicotine dependence
Body mass index (BMI)	Continuous variable; Categorical variable: <ul style="list-style-type: none"> • Underweight (<18.5) • Normal weight (18.5-24.9) • Overweight (25-29.9) • Obese (≥30 - <40) • Severe obesity (≥40) 	Calculated from height and weight data (kg/m ²) ICD-9-CM codes: <ul style="list-style-type: none"> • V85.0, Body Mass Index less than 19, adult • V85.1, Body Mass Index between 19-24, adult • V85.2, Body mass index between 25-29, adult • V85.3, Body mass index between 30-39, adult • V85.4, Body mass index 40 and over, adult ICD-10-CM codes:

090177e1962518d5\Approved\Approved On: 29-Jan-2021 20:00 (GMT)

Appendix Table 1. Demographic and Clinical Characteristics Definitions

Variable	Description	Operational definition
		<ul style="list-style-type: none"> • Z68.1, Body Mass Index 19.9 or less, adult • Z68.2, Body mass index 20-29, adult • Z68.3, Body mass index between 30-39, adult • Z68.4, Body mass index 40 and over, adult
History of anaphylaxis/allergic reactions	Dichotomous variable	ICD-9-CM code: <ul style="list-style-type: none"> • V13.81, Personal history of anaphylaxis • V14.0 - V14.6, V14.8, V14.9, Personal history of allergy to drugs, medications and biological substances, excluding serum and vaccine • V15.0x, Other allergy • 525.66, Allergy to existing dental restorative material • 995.0, Other anaphylactic shock, not elsewhere classified • 995.1, Angioneurotic edema, not elsewhere classified • 995.21, Arthus phenomenon • 999.27, Other drug allergy • 995.3, Allergy, unspecified, not elsewhere classified • 995.6x, Anaphylactic shock due to food • 999.41, Anaphylactic reaction due to administration of blood and blood products • 999.49, Anaphylactic reaction due to other serum ICD-10-CM code: <ul style="list-style-type: none"> • Z87.892 Personal history of anaphylaxis • Z88.0 - Z88.6, Z88.8, Z88.9, Allergy status to drugs,

090177e1962518d5\Approved\Approved On: 29-Jan-2021 20:00 (GMT)

Appendix Table 1. Demographic and Clinical Characteristics Definitions

Variable	Description	Operational definition
		<p>medications and biological substances, excluding serum and vaccine</p> <ul style="list-style-type: none"> • T78.00xx-T78.09xx, Anaphylactic reaction due to food, initial encounter, subsequent encounter and sequela • T78.2xxx, Anaphylactic shock, initial encounter, subsequent encounter and sequela • T78.3xxx, Angioneurotic edema, initial encounter, subsequent encounter and sequela • T78.41xx, Arthus phenomenon • T80.51xx, Anaphylactic reaction due to administration of blood and blood products, initial encounter, subsequent encounter and sequela • T80.59xx, Anaphylactic reaction due to other serum, initial encounter, subsequent encounter and sequela • T88.6xxx, Anaphylactic reaction due to adverse effect of correct drug or medicament properly administered, initial encounter, subsequent encounter and sequela
Previous anaphylaxis of vaccine component	Dichotomous variable	<p>ICD-9-CM code:</p> <ul style="list-style-type: none"> • 999.42, Anaphylactic reaction due to vaccination • V14.7, Personal history of allergy to serum or vaccine <p>ICD-10-CM codes:</p> <ul style="list-style-type: none"> • T80.52xx, Anaphylactic reaction due to vaccination,

090177e1962518d5\Approved\Approved On: 29-Jan-2021 20:00 (GMT)

Appendix Table 1. Demographic and Clinical Characteristics Definitions

Variable	Description	Operational definition
		initial encounter, subsequent encounter and sequela <ul style="list-style-type: none"> • Z28.04, Immunization not carried out because of patient allergy to vaccine or component • Z88.7, Allergy status to serum and vaccine
History of hospitalizations	Dichotomous variable; Continuous variable	Defined by having any hospitalizations (dichotomous) and number of hospitalizations (continuous)
Pregnancy	Dichotomous variable	LOINC code: <ul style="list-style-type: none"> • 82810-3, Pregnancy status • 11449-6, Pregnancy status - Reported ICD-9-CM codes: <ul style="list-style-type: none"> • V22.x, Normal pregnancy • V23.x, V23.xx, Supervision of high-risk pregnancy ICD-10-CM codes: <ul style="list-style-type: none"> • Z33.1, Pregnant state, incidental • Z33.3, Pregnant state, gestational carrier • Z34, Supervision of normal pregnancy • O09, Supervision of high risk pregnancy
Charlson Comorbidity Index (CCI)	Continuous variable	ICD-9-CM codes: <ul style="list-style-type: none"> • 410.x, 412.x, Myocardial infarction • 398.91, 402.01, 402.11, 402.91, 404.01, 404.03, 404.11, 404.13,

090177e1962518d5\Approved\Approved On: 29-Jan-2021 20:00 (GMT)

Appendix Table 1. Demographic and Clinical Characteristics Definitions

Variable	Description	Operational definition
		<p>404.91, 404.93, 425.4 - 425.9, 428.x, Congestive heart failure</p> <ul style="list-style-type: none"> • 093.0, 437.3, 440.x, 441.x, 443.1 - 443.9, 447.1, 557.1, 557.9, V43.4, Peripheral vascular disease • 362.34, 430.x - 438.x, Cerebrovascular disease • 290.x, 294.1, 331.2, Dementia • 416.8, 416.9, 490.x - 505.x, 506.4, 508.1, 508.8, Chronic pulmonary disease • 446.5, 710.0 - 710.4, 714.0 - 714.2, 714.8, 725.x, Rheumatic disease • 531.x - 534.x, Peptic ulcer disease • 070.22, 070.23, 070.32, 070.33, 070.44, 070.54, 070.6, 070.9, 570.x, 571.x, 573.3, 573.4, 573.8, 573.9, V42.7, Mild liver disease • 250.0 - 250.3, 250.8, 250.9, Diabetes without chronic complication • 250.4 - 250.7, Diabetes with chronic complication • 334.1, 342.x, 343.x, 344.0 - 344.6, 344.9, Hemiplegia or paraplegia • 403.01, 403.11, 403.91, 404.02, 404.03, 404.12, 404.13, 404.92, 404.93, 582.x, 583.0 - 583.7, 585.x, 586.x, 588.0, V42.0, V45.1, V56.x, Renal disease • 140.x - 172.x, 174.x - 195.8, 200.x - 208.x, 238.6, Any malignancy, including lymphoma and leukemia, except malignant neoplasm of skin

090177e1962518d5\Approved\Approved On: 29-Jan-2021 20:00 (GMT)

Appendix Table 1. Demographic and Clinical Characteristics Definitions

Variable	Description	Operational definition
		<ul style="list-style-type: none"> • 456.0 - 456.2, 572.2- 572.8, Moderate or severe liver disease • 196.x - 199.x, Metastatic solid tumor • 042.x - 044.x, Acquired immunodeficiency syndrome (AIDS)/Human immunodeficiency virus (HIV) <p>ICD-10-CM codes:</p> <ul style="list-style-type: none"> • I21.x, I21.xx, I22.x, I25.2, Myocardial infarction • I09.9, I11.0, I13.0, I13.2, I25.5, I42.0, I42.5 - I42.9, I43, I43.x, I50.x, I50.xx, Congestive heart failure • I70.x, I71.x, I73.1, I73.8, I73.9, I77.1, I79.0, I79.2, K55.1, K55.8, K55.9, Z95.8, Z95.9, Peripheral vascular disease • G45, G45.x, G46.x, H34.0, I60.x - I63.x, I60.xx - I63.xx, I60.xxx - I63.xxx, I65.x - I69.x, I65.xx - I69.xx, I65.xxx - I69.xxx, Cerebrovascular disease • F00.x - F03.x, F00.xx - F03.xx, F05, F05.1, G30.x, G31.1, Dementia • I27.8, I27.9, J40.x - J47.x, J40.xx - J47.xx, J40.xxx - J47.xxx, J60.x - J67.x, J68.4, J70.1, J70.3, Chronic pulmonary disease • M05, M05.x, M05.xx, M05.xxx, M06, M06.x, M06.xx, M06.xxx, M31.5, M32.x - M34.x, M32.xx - M34.xx, M35.1, M35.3, M36.0, Rheumatic disease • K25.x - K28.x, Peptic ulcer disease

090177e1962518d5\Approved\Approved On: 29-Jan-2021 20:00 (GMT)

Appendix Table 1. Demographic and Clinical Characteristics Definitions

Variable	Description	Operational definition
		<ul style="list-style-type: none"> • B18.x, K70.0 - K70.3, K70.9, K71.3 - K71.5, K71.7, K73.x, K74.x, K74.xx, K76.0, K76.2-K76.4, K76.8, K76.9, Z94.4, Mild liver disease • E10.0, E10.1x, E10.6x, E10.6xx, E10.8, E10.9, E11.0x, E11.1x, E11.6x, E11.6xx, E11.8, E11.9, E12.0, E12.1, E12.6, E12.8, E12.9, E13.0x, E13.1x, E13.6x, E13.6xx, E13.8, E13.9, E14.0, E14.1, E14.6, E14.8, E14.9, Diabetes without chronic complication • E10.2x - E10.5x, E10.2xx - E10.5xx, E10.7, E11.2x - E11.5x, E11.2xx - E11.5xx, E11.7, E12.2 - E12.5, E12.7, E13.2 - E13.5x, E13.7, E14.2 - E14.5, E14.7, Diabetes with chronic complication • G04.1, G11.4, G80.1, G80.2, G81.x, G81.xx, G82.x, G82.xx, G83.0, G83.1-G83.3, G83.1x-G83.3x, G83.4, G83.9, Hemiplegia or paraplegia • I12.0, I13.1x, N03.2 - N03.7, N05.2 - N05.7, N18.x, N19, N25.0, Z49.0x - Z49.3x, Z94.0, Z99.2, Renal disease • C00-C75, C00.x-C75.x, C00.xx-C75.xx (excluding C44, C44.x and C44.xx), C7A., C7A.x, C7A.xx, C7B., C7B.x, C7B.xx, C76-C80, C76.x-C80.x, C76.xx-C80.xx, C81-C96, C81.x-C96.x, C81.xx-C96.xx, Any malignancy, including lymphoma and leukemia, except malignant neoplasm of skin

090177e1962518d5\Approved\Approved On: 29-Jan-2021 20:00 (GMT)

Appendix Table 1. Demographic and Clinical Characteristics Definitions

Variable	Description	Operational definition
		<ul style="list-style-type: none"> • I85.0, I85.9, I86.4, I98.2, K70.4x, K71.1x, K72.1x, K72.9x, K76.5, K76.6, K76.7, Moderate or severe liver disease • C77.x - C80.x, C77.xx - C80.xx, Metastatic solid tumor • B20, B97.35, AIDS/HIV
Comorbidities	Categorical variable: <ul style="list-style-type: none"> • Autoimmune disease • Asthma • Bleeding diathesis or condition associated with prolonged bleeding • Cancer • Cardiovascular conditions (e.g., heart failure, CAD, cardiomyopathies) • Chronic kidney disease/dialysis • COPD/interstitial lung disease • Diabetes mellitus (ie, Type 2 diabetes) • Down syndrome • Sickle cell disease • HBV • HCV • HIV • Hyperlipidemia • Hypertension • Liver disease • Neurological disease 	Autoimmune disease (immunocompromised state [weakened immune system] from solid organ transplant): ICD-9-CM codes: <ul style="list-style-type: none"> • 245.2, Chronic lymphocytic thyroiditis • 340, Multiple sclerosis • 357, Acute infective polyneuritis • 357.4, Polyneuropathy in other diseases classified elsewhere • 696.1, Other psoriasis • 694.3, Impetigo herpetiformis • 696.1, Other psoriasis • 696, Psoriatic arthropathy • 695.4, Lupus erythematosus • 714, 714.x, 714.xx, Rheumatoid arthritis and other inflammatory polyarthropathies • 359.6, Symptomatic inflammatory myopathy in diseases classified elsewhere • 357.1, Polyneuropathy in collagen vascular disease • 714.89, Other specified inflammatory polyarthropathies

090177e1962518d5\Approved\Approved On: 29-Jan-2021 20:00 (GMT)

Appendix Table 1. Demographic and Clinical Characteristics Definitions

Variable	Description	Operational definition
	<ul style="list-style-type: none"> • Other immune deficiencies • Solid organ transplant • VTE 	<ul style="list-style-type: none"> • 714.9, Unspecified inflammatory polyarthropathy • 446.5, Giant cell arteritis • 710.2, Sicca syndrome <p>ICD-10-CM codes:</p> <ul style="list-style-type: none"> • D69.3, Immune thrombocytopenic purpura • E06.3, Autoimmune thyroiditis • G35, MS • G61.0 and G65.0, GBS and sequelae of GBS • L40.x, L40.5x, Psoriasis • L93.x, Lupus erythematosus • M05.x, M05.xx, M05.xxx, Rheumatoid arthritis with rheumatoid factor • M06.x, M06.xx, M06.xxx, Other rheumatoid arthritis • M31.5, M31.6, Giant cell arteritis • M35.0x, Sicca (Sjogren’s) syndrome • E10, E10.x, E10.xx, Type 1 diabetes mellitus • N05.9, Glomerulonephritis • D84.9, Immunodeficiency, unspecified <p>Asthma:</p> <ul style="list-style-type: none"> • ICD-9-CM codes: <ul style="list-style-type: none"> ○ 493.xx, Asthma • ICD-10-CM codes: <ul style="list-style-type: none"> ○ J45.2x - J45.3x, Mild intermittent asthma ○ J45.4x, Moderate persistent asthma ○ J45.5x, Severe persistent asthma

090177e1962518d5\Approved\Approved On: 29-Jan-2021 20:00 (GMT)

Appendix Table 1. Demographic and Clinical Characteristics Definitions

Variable	Description	Operational definition
		<ul style="list-style-type: none"> ○ J45.9x, Other and unspecified asthma <p>Bleeding diathesis or condition associated with prolonged bleeding:</p> <ul style="list-style-type: none"> ● ICD-9-CM codes: <ul style="list-style-type: none"> ○ 286.x, Coagulation defects ○ 289.8x, Other specified diseases of blood and blood-forming organs ○ 287, 287.x, 287.xx, Purpura and other hemorrhagic conditions ● ICD-10-CM codes: <ul style="list-style-type: none"> ○ D65, Disseminated intravascular coagulation ○ D66, Hereditary factor VIII deficiency ○ D67, Hereditary factor IX deficiency ○ D68, D68.x, D68.xx, Other coagulation defects ○ D69, D69.x, D69.xx, Purpura and other hemorrhagic conditions <p>Cancer:</p> <ul style="list-style-type: none"> ● ICD-9-CM codes: <ul style="list-style-type: none"> ○ 140.x -149.x, Malignant neoplasm of lip, oral cavity, and pharynx ○ 150.x -159.x, Malignant neoplasm of digestive organs and peritoneum

090177e1962518d5\Approved\Approved On: 29-Jan-2021 20:00 (GMT)

Appendix Table 1. Demographic and Clinical Characteristics Definitions

Variable	Description	Operational definition
		<ul style="list-style-type: none"> ○ 160.x -165.x, Malignant neoplasm of respiratory and intrathoracic organs ○ 170.x -176.x, Malignant neoplasm of bone, connective tissue, skin, and breast ○ 179.x - 189.x, Malignant neoplasm of genitourinary organs ○ 190.x - 199.x, Malignant neoplasm of other unspecified sites ○ 200.xx - 208.xx, Malignant neoplasm of lymphatic and hematopoietic tissue ○ 209.0x - 209.3x, Malignant neuroendocrine tumors ○ 230.x - 234.x, Carcinoma in situ of digestive organs ● ICD-10-CM codes: <ul style="list-style-type: none"> ○ C00-C75, C00.x-C75.x, C00.xx-C75.xx, C7A., C7A.x, C7A.xx, C7B., C7B.x, C7B.xx, Malignant neoplasms, stated or presumed to be primary (of specified sites), and certain specified histologies, except

090177e1962518d5\Approved\Approved On: 29-Jan-2021 20:00 (GMT)

Appendix Table 1. Demographic and Clinical Characteristics Definitions

Variable	Description	Operational definition
		<p>neuroendocrine, and of lymphoid, hematopoietic and related tissue</p> <ul style="list-style-type: none"> ○ C76-C80, C76.x-C80.x, C76.xx-C80.xx, Malignant neoplasms of ill-defined, other secondary and unspecified sites ○ C81-C96, C81.x-C96.x, C81.xx-C96.xx, Malignant neoplasms of lymphoid, hematopoietic and related tissue <p>Cardiovascular conditions (e.g., heart failure, coronary artery disease [CAD], cardiomyopathies):</p> <ul style="list-style-type: none"> ● ICD-9-CM codes: <ul style="list-style-type: none"> ○ 428.xx, Heart failure ○ 414.01, 429.2, 411.1, 413.9, 414.11, 414.12, 414.05, 414.02, 414.04, 414.03, 414.06, 414.07, 414.2, 411.81, 411.89, CAD ○ 425.xx, Cardiomyopathy ● ICD-10-CM codes: <ul style="list-style-type: none"> ○ 150.x, 150.xx, Heart failure ○ I24.0, I24.8, I24.9, I25.10, I25.110, I25.111, I25.118, I25.119, I25.41, I25.42, I25.700, I25.701, I25.708,

090177e1962518d5\Approved\Approved On: 29-Jan-2021 20:00 (GMT)

Appendix Table 1. Demographic and Clinical Characteristics Definitions

Variable	Description	Operational definition
		<p>I25.709, I25.710, I25.711, I25.718, I25.719, I25.720, I25.721, I25.728, I25.729, I25.730, I25.731, I25.738, I25.739, I25.750, I25.751, I25.758, I25.759, I25.760, I25.761, I25.768, I25.769, I25.790, I25.791, I25.798, I25.799, I25.810, I25.811, I25.812, CAD</p> <ul style="list-style-type: none"> ○ I42.x, Cardiomyopathy <p>Chronic kidney disease/dialysis:</p> <ul style="list-style-type: none"> ● ICD-9-CM codes: <ul style="list-style-type: none"> ○ 283.11, Hemolytic-uremic syndrome ○ 403, 403.x, 403.xx, Hypertensive chronic kidney disease ○ 404, 404.x, 404.xx, Hypertensive heart and chronic kidney disease ○ 440.1, Atherosclerosis of renal artery ○ 442.1, Aneurysm of renal artery ○ 572.4, Hepatorenal syndrome ○ 274.1, Gouty nephropathy, unspecified ○ 710, Systemic lupus erythematosus

090177e1962518d5\Approved\Approved On: 29-Jan-2021 20:00 (GMT)

Appendix Table 1. Demographic and Clinical Characteristics Definitions

Variable	Description	Operational definition
		<ul style="list-style-type: none"> ○ 710.2, Sicca syndrome ○ 580, 580.x, 580.xx, Acute glomerulonephritis ○ 581.x, 581.xx, Nephrotic syndrome ○ 582, 582.x, 582.xx, Chronic glomerulonephritis ○ 583, 583.x, 583,xx, Nephritis and nephropathy, not specified as acute or chronic ○ 591, Hydronephrosis ○ 593.3, Stricture or kinking of ureter ○ 592, Calculus of kidney ○ 592.1, Calculus of ureter ○ 590.9, Infection of kidney, unspecified ○ 584.x, Acute kidney failure ○ 585.x, Chronic kidney disease ○ 588.x, 588.xx, Disorders resulting from impaired renal function ○ 587, Renal sclerosis, unspecified ○ 753.1x, Cystic kidney disease ○ 753.2, 753.2x, Obstructive defects of renal pelvis and ureter <p>● ICD-10-CM codes:</p>

090177e1962518d5\Approved\Approved On: 29-Jan-2021 20:00 (GMT)

Appendix Table 1. Demographic and Clinical Characteristics Definitions

Variable	Description	Operational definition
		<ul style="list-style-type: none"> ○ D59.3, Hemolytic-uremic syndrome ○ I12.x, Hypertensive chronic kidney disease ○ I13.x, I13.xx, Hypertensive heart and chronic kidney disease ○ I70.1, Atherosclerosis of renal artery ○ I72.2 Aneurysm of renal artery ○ K76.7, Hepatorenal syndrome ○ M10.30-M10.39, M10.30x-M10.37x, Gout due to renal impairment ○ M32.14, Glomerular disease in systemic lupus erythematosus ○ M32.15, Tubulo-interstitial nephropathy in systemic lupus erythematosus ○ M3504, Sicca syndrome with tubulo-interstitial nephropathy ○ N00.x-N07.x, N08, Glomerular diseases ○ N13.1, N13.2, N13.3x, Obstructive and reflux uropathy ○ N14.x, Nephropathy ○ N15.x, Other renal tubulo-interstitial diseases

090177e1962518d5\Approved\Approved On: 29-Jan-2021 20:00 (GMT)

Appendix Table 1. Demographic and Clinical Characteristics Definitions

Variable	Description	Operational definition
		<ul style="list-style-type: none"> ○ N16, Renal tubulo-interstitial disorders in diseases classified elsewhere ○ N17.x, N18.x, N19, Acute kidney failure and chronic kidney disease ○ N25.x, N26.x, N25.xx, Other disorders of kidney and ureter ○ Q61.02, Q61.11x, Q61.2-Q61.9, Cystic kidney disease ○ Q62.x, Q62.xx, Congenital obstructive defects of renal pelvis and congenital malformation of ureter <p>COPD/interstitial lung disease:</p> <ul style="list-style-type: none"> ● ICD-9-CM codes: <ul style="list-style-type: none"> ○ 491.9, Unspecified chronic bronchitis ○ 492.8, Other emphysema ○ 491.x, 491.xx, Chronic bronchitis ○ 493.2, Chronic obstructive asthma, unspecified ○ 496, Chronic airway obstruction, not elsewhere classified ○ 516, 516.x, 516.xx, Other alveolar and parietoalveolar pneumonopathy

090177e1962518d5\Approved\Approved On: 29-Jan-2021 20:00 (GMT)

Appendix Table 1. Demographic and Clinical Characteristics Definitions

Variable	Description	Operational definition
		<ul style="list-style-type: none"> ○ 515, Postinflammatory pulmonary fibrosis ○ 518.x, 518.xx, Other diseases of lung ○ 714.81, Rheumatoid lung ● ICD-10-CM codes: <ul style="list-style-type: none"> ○ J41.x Simple and mucopurulent chronic bronchitis ○ J42, Unspecified chronic bronchitis ○ J43.x, Emphysema ○ J44.x, Other COPD ○ J80, J81.x, J82.xx, J84.xx, J84.xxx, Other respiratory diseases principally affecting the interstitium ○ M05.10, Rheumatoid lung disease with rheumatoid arthritis of unspecified site <p>Diabetes mellitus (ie, Type 2 diabetes):</p> <ul style="list-style-type: none"> ● ICD-9-CM codes: <ul style="list-style-type: none"> ○ 250.xx, Diabetes mellitus ● ICD-10-CM codes: <ul style="list-style-type: none"> ○ E11.x, E11.xx, E11.xxx, Type 2 diabetes mellitus <p>Down syndrome:</p> <ul style="list-style-type: none"> ● ICD-9-CM codes: <ul style="list-style-type: none"> ○ 758.x, Down syndrome ● ICD-10-CM codes: <ul style="list-style-type: none"> ○ Q90.x, Down syndrome <p>Sickle cell disease:</p>

090177e1962518d5\Approved\Approved On: 29-Jan-2021 20:00 (GMT)

Appendix Table 1. Demographic and Clinical Characteristics Definitions

Variable	Description	Operational definition
		<ul style="list-style-type: none"> • ICD-9-CM codes: <ul style="list-style-type: none"> ○ 282.xx, Sickle-cell disease • ICD-10-CM codes: <ul style="list-style-type: none"> ○ D57, D57.x, D57.xx, D57.xxx, Sickle-cell disorders <p>HBV:</p> <ul style="list-style-type: none"> • ICD-9-CM codes: <ul style="list-style-type: none"> ○ 70.33, Chronic viral hepatitis B without mention of hepatic coma with hepatitis delta ○ 70.32, Chronic viral hepatitis B without mention of hepatic coma without mention of hepatitis delta ○ 70.3, Viral hepatitis B without mention of hepatic coma, acute or unspecified, without mention of hepatitis delta ○ 70.2, Viral hepatitis B with hepatic coma, acute or unspecified, without mention of hepatitis delta • ICD-10-CM codes: <ul style="list-style-type: none"> ○ B18.0, B18.1, Chronic viral hepatitis B ○ B19.1, B19.1x, Unspecified viral hepatitis B <p>HCV:</p> <ul style="list-style-type: none"> • ICD-9-CM codes:

090177e1962518d5\Approved\Approved On: 29-Jan-2021 20:00 (GMT)

Appendix Table 1. Demographic and Clinical Characteristics Definitions

Variable	Description	Operational definition
		<ul style="list-style-type: none"> ○ 70.7, Unspecified viral hepatitis C without hepatic coma ○ 70.71, Unspecified viral hepatitis C with hepatic coma ○ 70.54, Chronic hepatitis C without mention of hepatic coma • ICD-10-CM codes: <ul style="list-style-type: none"> ○ B18.2, Chronic viral hepatitis C ○ B19.2x, Unspecified viral hepatitis C <p>HIV:</p> <ul style="list-style-type: none"> • ICD-9-CM codes: <ul style="list-style-type: none"> ○ 42, HIV disease ○ 79.53, HIV type 2 • ICD-10-CM codes: <ul style="list-style-type: none"> ○ B20, HIV disease ○ B97.35, HIV type 2 as the cause of diseases classified elsewhere <p>Hyperlipidemia</p> <ul style="list-style-type: none"> • ICD-9-CM codes: <ul style="list-style-type: none"> ○ 272.0x, Pure hypercholesterolemia ○ 272.1x, Pure hyperglyceridemia ○ 272.2x, Mixed hyperlipidemia ○ 272.4x, Hyperlipidemia, NOS • ICD-10-CM codes: <ul style="list-style-type: none"> ○ E78.0-E78.5, E78.0x, E78.4x, Hyperlipidemia <p>Hypertension:</p>

090177e1962518d5\Approved\Approved On: 29-Jan-2021 20:00 (GMT)

Appendix Table 1. Demographic and Clinical Characteristics Definitions

Variable	Description	Operational definition
		<ul style="list-style-type: none"> • ICD-9-CM codes: <ul style="list-style-type: none"> ○ 401.1, Benign essential hypertension ○ 401.9, Essential hypertension, NOS ○ 405.1, Benign secondary hypertension ○ 405.9, Secondary hypertension, NOS ○ 997.91, Hypertension, NOS • ICD-10-CM codes: <ul style="list-style-type: none"> ○ H35.03x, Hypertensive retinopathy ○ I10, I11.x-I16.x, I13.xx, Hypertensive diseases ○ I67.4, Hypertensive encephalopathy diseases <p>Liver disease:</p> <ul style="list-style-type: none"> • ICD-9-CM codes: <ul style="list-style-type: none"> ○ 571, 571.x, Alcoholic fatty liver ○ 572, 572.x, Hepatic encephalopathy ○ 573.x, Other disorder of liver ○ 570, Acute and subacute necrosis of liver • ICD-10-CM codes: <ul style="list-style-type: none"> ○ K70.x, K70.xx, Alcoholic fatty liver ○ K71.x, K71.xx, Toxic liver disease

090177e1962518d5\Approved\Approved On: 29-Jan-2021 20:00 (GMT)

Appendix Table 1. Demographic and Clinical Characteristics Definitions

Variable	Description	Operational definition
		<ul style="list-style-type: none"> ○ K72.xx, Hepatic failure, not elsewhere classified ○ K73.x, Chronic hepatitis, not elsewhere specified ○ K74.x, K74.xx, Fibrosis and cirrhosis of liver ○ K75.x, K75.xx, Other inflammatory liver diseases ○ K76.x, K76.xx, Other diseases of liver ○ K77, Liver disorders in diseases classified elsewhere <p>Neurological disease:</p> <ul style="list-style-type: none"> ● ICD-9-CM codes: <ul style="list-style-type: none"> ○ 780.97, Altered mental status ○ 780.93, Memory loss ○ 781.8, Neurologic neglect syndrome ○ 797, Senility without mention of psychosis ○ V62.89, Other psychological or physical stress, not elsewhere classified ○ 799.5x, Signs and symptoms involving cognition ○ 780.99, Other general symptoms ○ 780.4, Dizziness and giddiness ○ 781.1, Disturbances of sensation of smell and taste

090177e1962518d5\Approved\Approved On: 29-Jan-2021 20:00 (GMT)

Appendix Table 1. Demographic and Clinical Characteristics Definitions

Variable	Description	Operational definition
		<ul style="list-style-type: none"> ○ V41.5, Problems with smell and taste ○ 368.16, Psychophysical visual disturbances ○ 307.9, Other and unspecified special symptoms or syndromes, not elsewhere classified ○ 300.9, Unspecified nonpsychotic mental disorder ○ 300.9, Unspecified nonpsychotic mental disorder ○ 308.9, Unspecified acute reaction to stress ○ 307.9, Other and unspecified special symptoms or syndromes, not elsewhere classified ○ V62.85, Homicidal ideation ○ V62.84, Suicidal ideation ○ 799.24, Emotional lability ○ 799.23, Impulsiveness ○ 799.29, Other signs and symptoms involving emotional state ○ V40.39, Other specified behavioral problem ● ICD-10-CM codes:

090177e1962518d5\Approved\Approved On: 29-Jan-2021 20:00 (GMT)

Appendix Table 1. Demographic and Clinical Characteristics Definitions

Variable	Description	Operational definition
		<ul style="list-style-type: none"> ○ R41, R41.x, R41.xx, Other symptoms and signs involving cognitive functions and awareness ○ R42, Dizziness and giddiness ○ R43, R43.x, Disturbances of smell and taste ○ R44, R44.x, Other symptoms and signs involving general sensations and perceptions ○ R45, R45.x, R45. xx, Symptoms and signs involving emotional state ○ R46, R46.x, R46. xx, Symptoms and signs involving appearance and behavior <p>Other immune deficiencies:</p> <ul style="list-style-type: none"> ● ICD-9-CM codes: <ul style="list-style-type: none"> ○ 279.x, 279.xx, Deficiency of humoral immunity ○ 135, Sarcoidosis ○ 273.x, Disorders of plasma protein metabolism ● ICD-10-CM codes: <ul style="list-style-type: none"> ○ D80, D80.x, Immunodeficiency with predominantly antibody defects ○ D81, D81.x, D81.xx, Combined immunodeficiencies

090177e1962518d5\Approved\Approved On: 29-Jan-2021 20:00 (GMT)

Appendix Table 1. Demographic and Clinical Characteristics Definitions

Variable	Description	Operational definition
		<ul style="list-style-type: none"> ○ D82, D82.x, Immunodeficiency associated with other major defects ○ D83, D83.x, Common variable immunodeficiency ○ D84, D84.x, D84.xx, Other immunodeficiencies ○ D86, D86.x, D86.xx, Sarcoidosis ○ D89, D89.x, D89.xx, Other disorders involving the immune mechanism, not elsewhere classified <p>Solid organ transplant:</p> <ul style="list-style-type: none"> ● CPT codes: <ul style="list-style-type: none"> ○ 32850-32856, Transplantation of lung ○ 33930-33945, Transplantation of heart ○ 44132, 44133, 47133, 47135, 47140-47147, Transplantation of liver ○ 44135-44137, 44715, 44720, 44721, Transplantation of intestine ○ 48160, 48550-48552, 48554, 48556, Transplantation of pancreas ○ 50300, 50320, 50323, 50325,

090177e1962518d5\Approved\Approved On: 29-Jan-2021 20:00 (GMT)

Appendix Table 1. Demographic and Clinical Characteristics Definitions

Variable	Description	Operational definition
		<p>50327, 50328, 50329, 50340, 50340, 50360, 50365, 50370, 50380, Renal transplantation</p> <ul style="list-style-type: none"> • ICD-9-PCS codes: <ul style="list-style-type: none"> ○ 00.91 - 00.93, Transplant from donor or cadaver ○ 37.51, Heart transplantation ○ 33.51, Unilateral lung transplantation ○ 33.52, Bilateral lung transplantation ○ 46.97, Transplant of intestine ○ 50.59, Other transplant of intestine ○ 52.82, Homotransplant of pancreas ○ 55.69, Other kidney transplant • ICD-10-PCS codes: <ul style="list-style-type: none"> ○ 02YA0Z0, 02YA0Z1, Transplantation of heart ○ 0BYC0Z0, 0BYC0Z1, 0BYD0Z0, 0BYD0Z1, 0BYF0Z0, 0BYF0Z1, 0BYG0Z0, 0BYG0Z1, 0BYH0Z0, 0BYH0Z1,

090177e1962518d5\Approved\Approved On: 29-Jan-2021 20:00 (GMT)

Appendix Table 1. Demographic and Clinical Characteristics Definitions

Variable	Description	Operational definition
		<p>0BYJ0Z0, 0BYJ0Z1, 0BYK0Z0, 0BYK0Z1, 0BYL0Z0, 0BYL0Z1, 0BYM0Z0, 0BYM0Z1, Transplantation of lung</p> <ul style="list-style-type: none"> ○ 0DY60Z0, 0DY60Z1, Transplantation of stomach ○ 0DY80Z0, 0DY80Z1, Transplantation of small intestine ○ 0DYE0Z0, 0DYE0Z1, Transplantation of large intestine ○ 0FY00Z0, 0FY00Z1, Transplantation of liver ○ 0FYG0Z0, 0FYG0Z1, Transplantation of pancreas ○ 0TY00Z0, 0TY00Z1, 0TY10Z0, 0TY10Z1, Transplantation of kidney <p>VTE:</p> <ul style="list-style-type: none"> ● ICD-9-CM codes: <ul style="list-style-type: none"> ○ 415.1x, Pulmonary embolism and infarction ○ 451.x, 451.xx, Phlebitis and thrombophlebitis

090177e1962518d5\Approved\Approved On: 29-Jan-2021 20:00 (GMT)

Appendix Table 1. Demographic and Clinical Characteristics Definitions

Variable	Description	Operational definition
		<ul style="list-style-type: none"> ○ 452, Portal vein thrombosis ○ 453.x, 453.xx, Other venous embolism and thrombosis ● ICD-10-CM codes: <ul style="list-style-type: none"> ○ I26, I26.x, I26.xx, Pulmonary embolism ○ I80, I80.x, I80.xx, I80.xxx, Phlebitis and thrombophlebitis ○ I81, Portal vein thrombosis ○ I82, I82.x, I82.xx, I82.xxx Other venous embolism and thrombosis
Concurrent immunizations	Categorical variable: <ul style="list-style-type: none"> ● Seasonal influenza ● Tetanus diphtheria and pertussis (Tdap or Td) ● Chickenpox (Varicella) ● Shingles (Herpes Zoster recombinant and/or live) ● Human papillomavirus (HPV) ● Pneumococcal conjugate ● Pneumococcal polysaccharide ● Hepatitis A ● Hepatitis B ● Meningococcal conjugate (MenACWY) and serogroup B 	Description of immunization, immunization ID, lot number, and manufacturer code will be available. <p>Seasonal influenza:</p> <ul style="list-style-type: none"> ● CPT codes: <ul style="list-style-type: none"> ○ 90653, Influenza vaccine, inactivated (IIV), subunit, adjuvanted, for intramuscular use ○ 90724, Influenza virus vaccine ○ 90662, Influenza virus vaccine (IIV), split virus, preservative free, enhanced immunogenicity via increased antigen content, for intramuscular use ○ 90662, Influenza virus vaccine (IIV), split virus, preservative free, enhanced immunogenicity via increased antigen content, for intramuscular use

090177e1962518d5\Approved\Approved On: 29-Jan-2021 20:00 (GMT)

Appendix Table 1. Demographic and Clinical Characteristics Definitions

Variable	Description	Operational definition
	meningococcal (MenB) <ul style="list-style-type: none"> • Haemophilus influenza type b 	<ul style="list-style-type: none"> ○ 90694, Influenza virus vaccine, quadrivalent (aIIV4), inactivated, adjuvanted, preservative free, 0.5 mL dosage, for intramuscular use ○ 90756, Influenza virus vaccine, quadrivalent (ccIIV4), derived from cell cultures, subunit, antibiotic free, 0.5 mL dosage, for intramuscular use ○ 90674, Influenza virus vaccine, quadrivalent (ccIIV4), derived from cell cultures, subunit, preservative and antibiotic free, 0.5 mL dosage, for intramuscular use ○ 90688, Influenza virus vaccine, quadrivalent (IIV4), split virus, 0.5 mL dosage, for intramuscular use ○ 90686, Influenza virus vaccine, quadrivalent (IIV4), split virus, preservative free, 0.5 mL dosage, for intramuscular use ○ 90630, Influenza virus vaccine, quadrivalent (IIV4), split virus, preservative free, for intradermal use ○ 90682, Influenza virus vaccine, quadrivalent (RIV4), derived from recombinant DNA, hemagglutinin (HA) protein only, preservative and antibiotic free, for intramuscular use

090177e1962518d5\Approved\Approved On: 29-Jan-2021 20:00 (GMT)

Appendix Table 1. Demographic and Clinical Characteristics Definitions

Variable	Description	Operational definition
		<ul style="list-style-type: none"> ○ 90672, Influenza virus vaccine, quadrivalent, live (LAIV4), for intranasal use ○ 90661, Influenza virus vaccine, trivalent (ccIV3), derived from cell cultures, subunit, preservative and antibiotic free, 0.5 mL dosage, for intramuscular use ○ 90658, Influenza virus vaccine, trivalent (IIV3), split virus, 0.5 mL dosage, for intramuscular use ○ 90656, Influenza virus vaccine, trivalent (IIV3), split virus, preservative free, 0.5 mL dosage, for intramuscular use ○ 90654, Influenza virus vaccine, trivalent (IIV3), split virus, preservative-free, for intradermal use ○ 90673, Influenza virus vaccine, trivalent (RIV3), derived from recombinant DNA, hemagglutinin (HA) protein only, preservative and antibiotic free, for intramuscular use ○ 90660, Influenza virus vaccine, trivalent, live (LAIV3), for intranasal use ○ 90659, Influenza virus vaccine, whole virus, for intramuscular or jet injection use ● HCPCs codes: <ul style="list-style-type: none"> ○ G0008, Administration of influenza virus vaccine

090177e1962518d5\Approved\Approved On: 29-Jan-2021 20:00 (GMT)

Appendix Table 1. Demographic and Clinical Characteristics Definitions

Variable	Description	Operational definition
		<ul style="list-style-type: none"> ○ G8482, Influenza immunization administered or previously received ○ Q2034, Influenza virus vaccine, split virus, for intramuscular use (Agriflu) ○ Q2035, Influenza virus vaccine, split virus, when administered to individuals 3 years of age and older, for intramuscular use (Afluria) ○ Q2036, Influenza virus vaccine, split virus, when administered to individuals 3 years of age and older, for intramuscular use (Flulaval) ○ Q2037, Influenza virus vaccine, split virus, when administered to individuals 3 years of age and older, for intramuscular use (Fluvirin) ○ Q2038, Influenza virus vaccine, split virus, when administered to individuals 3 years of age and older, for intramuscular use (Fluzone) ○ Q2039, Influenza virus vaccine, not otherwise specified <p>Tetanus diphtheria and pertussis (Tdap or Td):</p>

090177e1962518d5\Approved\Approved On: 29-Jan-2021 20:00 (GMT)

Appendix Table 1. Demographic and Clinical Characteristics Definitions

Variable	Description	Operational definition
		<ul style="list-style-type: none"> • CPT codes: <ul style="list-style-type: none"> ○ 90714, Tetanus and diphtheria toxoids adsorbed (Td), preservative free, when administered to individuals 7 years or older, for intramuscular use ○ 90715, Tdap administered to individuals 7 years or older, for intramuscular use ○ 90718, Tetanus and diphtheria toxoids (Td) adsorbed when administered to individuals 7 years or older, for intramuscular use <p>Chickenpox (Varicella)</p> <ul style="list-style-type: none"> • CPT codes: <ul style="list-style-type: none"> ○ 90396, Varicella-zoster immune globulin, human, for intramuscular use ○ 90716, Varicella virus vaccine, live, for subcutaneous use <p>Shingles (Herpes Zoster recombinant and/or live)</p> <ul style="list-style-type: none"> • CPT codes: <ul style="list-style-type: none"> ○ 90396, Varicella-zoster immune globulin, human, for intramuscular use ○ 90736, Zoster (shingles) vaccine (HZV), live, for subcutaneous injection ○ 90750, Zoster (shingles) vaccine (HZV), recombinant, subunit, adjuvanted, for intramuscular use <p>Human papillomavirus (HPV)</p> <ul style="list-style-type: none"> • CPT codes: <ul style="list-style-type: none"> ○ 90649, Human Papillomavirus vaccine, types 6, 11, 16, 18, quadrivalent

090177e1962518d5\Approved\Approved On: 29-Jan-2021 20:00 (GMT)

Appendix Table 1. Demographic and Clinical Characteristics Definitions

Variable	Description	Operational definition
		<p>(4vHPV), 3 dose schedule, for intramuscular use</p> <ul style="list-style-type: none"> ○ 90650, Human Papillomavirus vaccine, types 16, 18, bivalent (2vHPV), 3 dose schedule, for intramuscular use ○ 90651, Human Papillomavirus vaccine types 6, 11, 16, 18, 31, 33, 45, 52, 58, nonavalent (9vHPV), 2 or 3 dose schedule, for intramuscular use <p>Pneumococcal conjugate</p> <ul style="list-style-type: none"> • CPT codes: <ul style="list-style-type: none"> ○ 90669, Pneumococcal conjugate vaccine, 7 valent, for intramuscular use ○ 90670, Pneumococcal conjugate vaccine, 13 valent (PCV13), for intramuscular use • HCPCS codes (used pneumococcal conjugate and polysaccharide): <ul style="list-style-type: none"> ○ G0009, Administration of pneumococcal vaccine ○ G8864, Code for Pneumococcal vaccine administered or previously received <p>Pneumococcal polysaccharide:</p> <ul style="list-style-type: none"> • CPT code: <ul style="list-style-type: none"> ○ 90732, Pneumococcal polysaccharide vaccine, 23-valent (PPSV23), adult or immunosuppressed patient dosage, when administered to individuals 2 years or older, for subcutaneous or intramuscular use

090177e1962518d5\Approved\Approved On: 29-Jan-2021 20:00 (GMT)

Appendix Table 1. Demographic and Clinical Characteristics Definitions

Variable	Description	Operational definition
		<p>Hepatitis A</p> <ul style="list-style-type: none"> • CPT codes <ul style="list-style-type: none"> ○ 90632, Hepatitis A vaccine, adult dosage, for intramuscular use ○ 90633, Hepatitis A vaccine (HepA), pediatric/adolescent dosage-2 dose schedule, for intramuscular use ○ 90634, Hepatitis A vaccine (HepA), pediatric/adolescent dosage-3 dose schedule, for intramuscular use ○ 90730, Hepatitis A vaccine ○ 90636, Hepatitis A and hepatitis B vaccine (HepA-HepB), adult dosage, for intramuscular use <p>Hepatitis B</p> <ul style="list-style-type: none"> • CPT codes: <ul style="list-style-type: none"> ○ 907311, Hepatitis B vaccine ○ 90739, Hepatitis B vaccine (HepB), adult dosage, 2 dose schedule, for intramuscular use ○ 90740, Hepatitis B vaccine (HepB), dialysis or immunosuppressed patient dosage, 3 dose schedule, for intramuscular use ○ 90743, Hepatitis B vaccine (HepB), adolescent, 2 dose schedule, for intramuscular use ○ 90744, Hepatitis B vaccine (HepB), pediatric/adolescent dosage, 3 dose schedule, for intramuscular use ○ 90745, Hepatitis B vaccine, adolescent/high risk infant dosage, for intramuscular use

090177e1962518d5\Approved\Approved On: 29-Jan-2021 20:00 (GMT)

Appendix Table 1. Demographic and Clinical Characteristics Definitions

Variable	Description	Operational definition
		<ul style="list-style-type: none"> ○ 90746, Hepatitis B vaccine (HepB), adult dosage, 3 dose schedule, for intramuscular use ○ 90747, Hepatitis B vaccine (HepB), dialysis or immunosuppressed patient dosage, 4 dose schedule, for intramuscular use • HCPCS codes: <ul style="list-style-type: none"> ○ G0010, Administration of Hepatitis B vaccine <p>Meningococcal conjugate (MenACWY) and serogroup B meningococcal (MenB)</p> <ul style="list-style-type: none"> • CPT codes: <ul style="list-style-type: none"> ○ 90619, Meningococcal conjugate vaccine, serogroups A, C, W, Y, quadrivalent, tetanus toxoid carrier (MenACWY-TT), for intramuscular use ○ 90620, Meningococcal recombinant protein and outer membrane vesicle vaccine, serogroup B (MenB-4C), 2 dose schedule, for intramuscular use ○ 90621, Meningococcal recombinant lipoprotein vaccine, serogroup B (MenB-FHbp), 2 or 3 dose schedule, for intramuscular use ○ 90733, Meningococcal polysaccharide vaccine, serogroups A, C, Y, W-135, quadrivalent (MPSV4), for subcutaneous use 90734, Meningococcal conjugate vaccine, serogroups A, C, W, Y, quadrivalent, diphtheria

090177e1962518d5\Approved\Approved On: 29-Jan-2021 20:00 (GMT)

Appendix Table 1. Demographic and Clinical Characteristics Definitions

Variable	Description	Operational definition
		<p>toxoid carrier (MenACWY-D) or CRM197 carrier (MenACWY-CRM), for intramuscular use</p> <p>Haemophilus influenzae type b</p> <ul style="list-style-type: none"> • CPT codes: <ul style="list-style-type: none"> ○ 90645, Hemophilus influenzae b vaccine (Hib), HbOC conjugate (4 dose schedule), for intramuscular use ○ 90646, Hemophilus influenzae b vaccine (Hib), PRP-D conjugate, for booster use only, intramuscular use ○ 90647, Haemophilus influenzae type b vaccine (Hib), PRP-OMP conjugate, 3 dose schedule, for intramuscular use ○ 90648, Haemophilus influenzae type b vaccine (Hib), PRP-T conjugate, 4 dose schedule, for intramuscular use ○ 90737, Hemophilus influenzae B ○ 90748, Hepatitis B and Haemophilus influenzae type b vaccine (Hib-HepB), for intramuscular use

090177e1962518d5\Approved\Approved On: 29-Jan-2021 20:00 (GMT)

Appendix Table 2. Operational Definitions of Safety Events of Interest

Variable	Operational Definition	
	Defined by the presence of any of the following ICD-9-CM codes (inclusive) ¹ :	Defined by the presence of any of the following ICD-10-CM codes (inclusive) ¹ :
Neurologic		
<i>Generalized convulsions/seizures</i> ^{9,25}	<ul style="list-style-type: none"> • 345, Epilepsy and recurrent seizures • 780.3, Convulsions • 780.31, Febrile convulsions (simple), unspecified • 780.39, Other convulsions 	<ul style="list-style-type: none"> • G40.A01, Absence epileptic syndrome, not intractable, with status epilepticus • G40.A09, Absence epileptic syndrome, not intractable, without status epilepticus • G40.A11, Absence epileptic syndrome, intractable, with status epilepticus • G40.A19, Absence epileptic syndrome, intractable, without status epilepticus • G40.101, Localization-related (focal) (partial) symptomatic epilepsy and epileptic syndromes with simple partial seizures, not

090177e1962518d5\Approved\Approved On: 29-Jan-2021 20:00 (GMT)

Appendix Table 2. Operational Definitions of Safety Events of Interest

Variable	Operational Definition	
	Defined by the presence of any of the following ICD-9-CM codes (inclusive) ¹ :	Defined by the presence of any of the following ICD-10-CM codes (inclusive) ¹ :
		intractable, with status epilepticus <ul style="list-style-type: none"> • G40.109, Localization-related (focal) (partial) symptomatic epilepsy and epileptic syndromes with simple partial seizures, not intractable, without status epilepticus • G40.111, Localization-related (focal) (partial) symptomatic epilepsy and epileptic syndromes with simple partial seizures, intractable, with status epilepticus • G40.119, Localization-related (focal) (partial) symptomatic epilepsy and epileptic syndromes with simple partial seizures,

090177e1962518d5\Approved\Approved On: 29-Jan-2021 20:00 (GMT)

Appendix Table 2. Operational Definitions of Safety Events of Interest

Variable	Operational Definition	
	Defined by the presence of any of the following ICD-9-CM codes (inclusive) ¹ :	Defined by the presence of any of the following ICD-10-CM codes (inclusive) ¹ :
		intractable, without status epilepticus <ul style="list-style-type: none"> • G40.201, Localization-related (focal) (partial) symptomatic epilepsy and epileptic syndromes with complex partial seizures, not intractable, with status epilepticus • G40.209, Localization-related (focal) (partial) symptomatic epilepsy and epileptic syndromes with complex partial seizures, not intractable, without status epilepticus • G40.211, Localization-related (focal) (partial) symptomatic epilepsy and epileptic

090177e1962518d5\Approved\Approved On: 29-Jan-2021 20:00 (GMT)

Appendix Table 2. Operational Definitions of Safety Events of Interest

Variable	Operational Definition	
	Defined by the presence of any of the following ICD-9-CM codes (inclusive) ¹ :	Defined by the presence of any of the following ICD-10-CM codes (inclusive) ¹ :
		<p>syndromes with complex partial seizures, intractable, with status epilepticus</p> <ul style="list-style-type: none"> • G40.219, Localization-related (focal) (partial) symptomatic epilepsy and epileptic syndromes with complex partial seizures, intractable, without status epilepticus • G40.309, Generalized idiopathic epilepsy and epileptic syndromes, not intractable, without status epilepticus • G40.311, Generalized idiopathic epilepsy and epileptic syndromes, intractable, with status epilepticus

090177e1962518d5\Approved\Approved On: 29-Jan-2021 20:00 (GMT)

Appendix Table 2. Operational Definitions of Safety Events of Interest

Variable	Operational Definition	
	Defined by the presence of any of the following ICD-9-CM codes (inclusive) ¹ :	Defined by the presence of any of the following ICD-10-CM codes (inclusive) ¹ :
		<ul style="list-style-type: none"> • G40.401, Other generalized epilepsy and epileptic syndromes, not intractable, with status epilepticus • G40.409, Other generalized epilepsy and epileptic syndromes, not intractable, without status epilepticus • G40.411, Other generalized epilepsy and epileptic syndromes, intractable, with status epilepticus • G40.419, Other generalized epilepsy and epileptic syndromes, intractable, without status epilepticus

090177e1962518d5\Approved\Approved On: 29-Jan-2021 20:00 (GMT)

Appendix Table 2. Operational Definitions of Safety Events of Interest

Variable	Operational Definition	
	Defined by the presence of any of the following ICD-9-CM codes (inclusive) ¹ :	Defined by the presence of any of the following ICD-10-CM codes (inclusive) ¹ :
		<ul style="list-style-type: none"> • G40.501, Epileptic seizures related to external causes, not intractable, with status epilepticus • G40.509, Epileptic seizures related to external causes, not intractable, without status epilepticus • G40.802, Other epilepsy, not intractable, without status epilepticus • G40.804, Other epilepsy, intractable, without status epilepticus • G40.821, Epileptic spasms, not intractable, with status epilepticus • G40.822, Epileptic spasms, not

090177e1962518d5\Approved\Approved On: 29-Jan-2021 20:00 (GMT)

Appendix Table 2. Operational Definitions of Safety Events of Interest

Variable	Operational Definition	
	Defined by the presence of any of the following ICD-9-CM codes (inclusive) ¹ :	Defined by the presence of any of the following ICD-10-CM codes (inclusive) ¹ :
		intractable, without status epilepticus <ul style="list-style-type: none"> • G40.823, Epileptic spasms, intractable, with status epilepticus • G40.824, Epileptic spasms, intractable, without status epilepticus • G40.901, Epilepsy, unspecified, not intractable, with status epilepticus • G40.909, Epilepsy, unspecified, not intractable, without status epilepticus • R56.00, Simple febrile convulsions • R56.01, Complex febrile convulsions • R56.9, Unspecified convulsions

090177e1962518d5\Approved\Approved On: 29-Jan-2021 20:00 (GMT)

Appendix Table 2. Operational Definitions of Safety Events of Interest

Variable	Operational Definition	
	Defined by the presence of any of the following ICD-9-CM codes (inclusive) ¹ :	Defined by the presence of any of the following ICD-10-CM codes (inclusive) ¹ :
<i>Guillain-Barré syndrome (GBS)</i> ^{9,25}	<ul style="list-style-type: none"> • 357.0, Guillain-Barre syndrome 	<ul style="list-style-type: none"> • G61.0, Guillain-Barre syndrome
Aseptic meningitis ⁵⁷	<ul style="list-style-type: none"> • 322.1, Eosinophilic meningitis • 322.9, Meningitis, unspecified 	<ul style="list-style-type: none"> • G038, Meningitis due to other specified causes • G039, Meningitis, unspecified
Encephalitis/encephalomyelitis ^{9,25}	<ul style="list-style-type: none"> • 323.5, Encephalitis, myelitis, and encephalomyelitis following immunization procedures • 323.51, Encephalitis and encephalomyelitis following immunization procedures • 323.52, Myelitis following immunization procedures • 323.6, Postinfectious encephalitis, myelitis, and encephalomyelitis • 323.61, Infectious acute disseminated encephalomyelitis (ADEM) • 323.62, Other postinfectious encephalitis and encephalomyelitis • 323.63, Postinfectious myelitis 	<ul style="list-style-type: none"> • G04.00, Acute disseminated encephalitis and encephalomyelitis, unspecified • G04.01, Postinfectious acute disseminated encephalitis and encephalomyelitis (postinfectious ADEM) • G04.02, Postimmunization acute disseminated

090177e1962518d5\Approved\Approved On: 29-Jan-2021 20:00 (GMT)

Appendix Table 2. Operational Definitions of Safety Events of Interest

Variable	Operational Definition	
	Defined by the presence of any of the following ICD-9-CM codes (inclusive) ¹ :	Defined by the presence of any of the following ICD-10-CM codes (inclusive) ¹ :
	<ul style="list-style-type: none"> • 323.8, Other causes of encephalitis, myelitis, and encephalomyelitis • 323.81, Other causes of encephalitis and encephalomyelitis • 323.82, Other causes of myelitis • 323.9, Unspecified causes of encephalitis, myelitis, and encephalomyelitis 	<ul style="list-style-type: none"> • encephalitis, myelitis and encephalomyelitis • G04.30, Acute necrotizing hemorrhagic encephalopathy, unspecified • G04.31, Postinfectious acute necrotizing • G04.32, Postimmunization acute necrotizing hemorrhagic encephalopathy • hemorrhagic encephalopathy • G04.39, Other acute necrotizing hemorrhagic encephalopathy • G05.4, Myelitis in diseases classified elsewhere

090177e1962518d5\Approved\Approved On: 29-Jan-2021 20:00 (GMT)

Appendix Table 2. Operational Definitions of Safety Events of Interest

Variable	Operational Definition	
	Defined by the presence of any of the following ICD-9-CM codes (inclusive) ¹ :	Defined by the presence of any of the following ICD-10-CM codes (inclusive) ¹ :
		<ul style="list-style-type: none"> • G04.81, Other encephalitis and encephalomyelitis • G04.89, Other myelitis • G04.90, Encephalitis and encephalomyelitis, unspecified • G04.91, Myelitis, unspecified
Other acute demyelinating diseases (excluding those limited as separate outcomes) ^{9,25}	<ul style="list-style-type: none"> • 341.0, Neuromyelitis optica • 341.1, Schilder's disease • 341.8, Other demyelinating diseases of central nervous system • 341.9, Demyelinating disease of central nervous system, unspecified • 357.81, Chronic inflammatory demyelinating polyneuritis 	<ul style="list-style-type: none"> • G37.1, Central demyelination of corpus callosum • G37.2, Central pontine myelinolysis • G37.8, Other specified demyelinating diseases of central nervous system • G37.9, Demyelinating disease of central nervous system, unspecified

090177e1962518d5\Approved\Approved On: 29-Jan-2021 20:00 (GMT)

Appendix Table 2. Operational Definitions of Safety Events of Interest

Variable	Operational Definition	
	Defined by the presence of any of the following ICD-9-CM codes (inclusive) ¹ :	Defined by the presence of any of the following ICD-10-CM codes (inclusive) ¹ :
		<ul style="list-style-type: none"> G61.81, Chronic inflammatory demyelinating polyneuritis
Transverse myelitis (TM) ^{9,25}	<ul style="list-style-type: none"> 341.2, Acute (transverse) myelitis 	<ul style="list-style-type: none"> G37.3, Acute transverse myelitis in demyelinating disease of central nervous system
Multiple sclerosis (MS) ^{9,25}	<ul style="list-style-type: none"> 340, Multiple sclerosis 	<ul style="list-style-type: none"> G35, Multiple sclerosis
Optic neuritis (ON) ^{9,25}	<ul style="list-style-type: none"> 377.30, Optic neuritis, unspecified 377.31, Optic papillitis 377.32, Retrobulbar neuritis (acute) 377.34, Toxic optic neuropathy 377.39, Other optic neuritis 	<ul style="list-style-type: none"> G36.0, Neuromyelitis optica [Devic] H46.0, Optic papillitis, unspecified eye H46.1, Retrobulbar neuritis, unspecified eye H46.3, Toxic optic neuropathy H46.8, Other optic neuritis

090177e1962518d5\Approved\Approved On: 29-Jan-2021 20:00 (GMT)

Appendix Table 2. Operational Definitions of Safety Events of Interest

Variable	Operational Definition	
	Defined by the presence of any of the following ICD-9-CM codes (inclusive) ¹ :	Defined by the presence of any of the following ICD-10-CM codes (inclusive) ¹ :
		<ul style="list-style-type: none"> • H46.9, Unspecified optic neuritis
Bell’s palsy ^{9,25}	<ul style="list-style-type: none"> • 351.0, Bell’s Palsy 	<ul style="list-style-type: none"> • G51.0, Bell's palsy
Immunologic		
Anaphylaxis ^{9,25}	<ul style="list-style-type: none"> • 999.4, Anaphylactic shock due to serum not elsewhere specified • 995.0, Other anaphylactic reaction 	<ul style="list-style-type: none"> • T78.2XXA, Anaphylactic shock, unspecified, initial encounter • T80.52XA, Anaphylactic reaction due to vaccination, initial encounter
Vasculitides (excluding those limited as separate outcomes) ^{58,59}	<ul style="list-style-type: none"> • 136.1, Behcet’s disease • 273.2, Other paraproteinemias • 287.0, Allergic purpura (Henoch-Schonlein Purpura) • 443.1, Thromboangiitis obliterans (Buerger’s disease) • 446.0, Polyarteritis nodosa • 446.4, Wegener’s granulomatosis 	<ul style="list-style-type: none"> • D69.0, Allergic purpura (Henoch-Schonlein Purpura) • D89.1, Cryoglobulinemia • I73.1, Thromboangiitis obliterans (Buerger’s disease)

090177e1962518d5\Approved\Approved On: 29-Jan-2021 20:00 (GMT)

Appendix Table 2. Operational Definitions of Safety Events of Interest

Variable	Operational Definition	
	Defined by the presence of any of the following ICD-9-CM codes (inclusive) ¹ :	Defined by the presence of any of the following ICD-10-CM codes (inclusive) ¹ :
	<ul style="list-style-type: none"> • 446.5, Giant cell arteritis • 446.7, Takayasu’s disease • 447.6, Arteritis, unspecified • 	<ul style="list-style-type: none"> • I77.6, Arteritis, unspecified • M30.0, Polyarteriitis nodosa • M30.1, Polyarteritis with lung involvement (Churg-Strauss) • M31.3, Wegener’s granulomatosis • M31.4, Aortic arch syndrome (Takayasu’s disease) • M31.5, Giant cell arteritis with other polymyalgia rheumatica • M31.6, Other giant cell arteritis • M31.7, Microscopic polyangiitis • M35.2, Behcet’s disease

090177e1962518d5\Approved\Approved On: 29-Jan-2021 20:00 (GMT)

Appendix Table 2. Operational Definitions of Safety Events of Interest

Variable	Operational Definition	
	Defined by the presence of any of the following ICD-9-CM codes (inclusive) ¹ :	Defined by the presence of any of the following ICD-10-CM codes (inclusive) ¹ :
		<ul style="list-style-type: none"> • M35.3, Polymyalgia rheumatica
Arthritis and arthralgia/joint pain (not osteoarthritis or traumatic arthritis) ⁵⁷	<ul style="list-style-type: none"> • 713.6, Arthropathy associated with hypersensitivity reaction • 999.52, Other serum reaction due to vaccination 	<ul style="list-style-type: none"> • M02.20, Postimmunization arthropathy, unspecified site • M02.211, Postimmunization arthropathy, right shoulder • M02.212, Postimmunization arthropathy, left shoulder • M02.219, Postimmunization arthropathy, unspecified shoulder • M02.221, Postimmunization arthropathy, right elbow

090177e1962518d5\Approved\Approved On: 29-Jan-2021 20:00 (GMT)

Appendix Table 2. Operational Definitions of Safety Events of Interest

Variable	Operational Definition	
	Defined by the presence of any of the following ICD-9-CM codes (inclusive) ¹ :	Defined by the presence of any of the following ICD-10-CM codes (inclusive) ¹ :
		<ul style="list-style-type: none"> • M02.222, Postimmunization arthropathy, left elbow • M02.229, Postimmunization arthropathy, unspecified elbow • M02.231, Postimmunization arthropathy, right wrist • M02.232, Postimmunization arthropathy, left wrist • M02.239, Postimmunization arthropathy, unspecified wrist • M02.241, Postimmunization arthropathy, right hand • M02.242, Postimmunization arthropathy, left hand

090177e1962518d5\Approved\Approved On: 29-Jan-2021 20:00 (GMT)

Appendix Table 2. Operational Definitions of Safety Events of Interest

Variable	Operational Definition	
	Defined by the presence of any of the following ICD-9-CM codes (inclusive) ¹ :	Defined by the presence of any of the following ICD-10-CM codes (inclusive) ¹ :
		<ul style="list-style-type: none"> • M02.249, Postimmunization arthropathy, unspecified hand • M02.251, Postimmunization arthropathy, right hip • M02.252, Postimmunization arthropathy, left hip • M02.259, Postimmunization arthropathy, unspecified hip • M02.261, Postimmunization arthropathy, right knee • M02.262, Postimmunization arthropathy, left knee • M02.269, Postimmunization

090177e1962518d5\Approved\Approved On: 29-Jan-2021 20:00 (GMT)

Appendix Table 2. Operational Definitions of Safety Events of Interest

Variable	Operational Definition	
	Defined by the presence of any of the following ICD-9-CM codes (inclusive) ¹ :	Defined by the presence of any of the following ICD-10-CM codes (inclusive) ¹ :
		<ul style="list-style-type: none"> arthropathy, unspecified knee • M02.271, Postimmunization arthropathy, right ankle and foot • M02.272, Postimmunization arthropathy, left ankle and foot • M02.279, Postimmunization arthropathy, unspecified ankle and foot • M02.28, Postimmunization arthropathy, vertebrae • M02.29, Postimmunization arthropathy, multiple sites • M15.8, Other polyosteoarthritis

090177e1962518d5\Approved\Approved On: 29-Jan-2021 20:00 (GMT)

Appendix Table 2. Operational Definitions of Safety Events of Interest

Variable	Operational Definition	
	Defined by the presence of any of the following ICD-9-CM codes (inclusive) ¹ :	Defined by the presence of any of the following ICD-10-CM codes (inclusive) ¹ :
		<ul style="list-style-type: none"> • M15.9, Polyosteoarthritis, unspecified • M19.9, Unspecified osteoarthritis, unspecified site
<i>Multisystem inflammatory syndrome in adults (MIS-A)</i> ⁵⁷	N/A	<ul style="list-style-type: none"> • M35.81, Multisystem inflammatory syndrome
<i>Kawasaki disease (KD)</i> ⁵⁷	<ul style="list-style-type: none"> • 446.1, Acute febrile mucocutaneous lymph node syndrome [MCLS] 	<ul style="list-style-type: none"> • M30.3, Mucocutaneous lymph node syndrome [Kawasaki]
Fibromyalgia ⁵⁷	<ul style="list-style-type: none"> • 729.1, Myalgia and myositis, unspecified 	<ul style="list-style-type: none"> • M79.7, Fibromyalgia
Autoimmune thyroiditis ⁵⁷	N/A	<ul style="list-style-type: none"> • E06.3, Autoimmune thyroiditis
Cardiac		

090177e1962518d5\Approved\Approved On: 29-Jan-2021 20:00 (GMT)

Appendix Table 2. Operational Definitions of Safety Events of Interest

Variable	Operational Definition	
	Defined by the presence of any of the following ICD-9-CM codes (inclusive) ¹ :	Defined by the presence of any of the following ICD-10-CM codes (inclusive) ¹ :
<i>Myocarditis</i> ^{9,25}	<ul style="list-style-type: none"> • 422, Acute myocarditis in diseases classified elsewhere • 422.9, Acute myocarditis, unspecified • 422.91, Idiopathic myocarditis • 422.99, Other acute myocarditis 	<ul style="list-style-type: none"> • I41, Myocarditis in diseases classified elsewhere • I40.0, Infective myocarditis • I40.1, Isolated myocarditis • I40.8, Other acute myocarditis • I40.9, Acute myocarditis, unspecified
<i>Pericarditis</i> ^{9,25}	<ul style="list-style-type: none"> • 420.9, Acute pericarditis, unspecified • 420.91, Acute idiopathic pericarditis 	<ul style="list-style-type: none"> • I30.0, Acute nonspecific idiopathic pericarditis • I30.9, Acute pericarditis, unspecified
<i>Acute myocardial infarction (AMI)</i> ⁵⁷	<ul style="list-style-type: none"> • 410, Acute myocardial infarction 	<ul style="list-style-type: none"> • I21, Acute myocardial infarction

090177e1962518d5\Approved\Approved On: 29-Jan-2021 20:00 (GMT)

Appendix Table 2. Operational Definitions of Safety Events of Interest

Variable	Operational Definition	
	Defined by the presence of any of the following ICD-9-CM codes (inclusive) ¹ :	Defined by the presence of any of the following ICD-10-CM codes (inclusive) ¹ :
Hematologic		
<i>Thrombocytopenia</i>	<ul style="list-style-type: none"> • 287.30-287.39, Primary thrombocytopenia • 287.41-287.49, Secondary thrombocytopenia • 287.5, Thrombocytopenia, unspecified 	<ul style="list-style-type: none"> • D69.3, D69.4, Primary thrombocytopenic • D69.5, Other secondary thrombocytopenia • D69.6, Thrombocytopenia, unspecified
<i>Disseminated intravascular coagulation (DIC)</i> ⁵⁷	<ul style="list-style-type: none"> • 286.6, Defibrination syndrome 	<ul style="list-style-type: none"> • D65, Disseminated intravascular coagulation [defibrination syndrome]
COVID-19	<p>Note that ICD-9-CM codes are not included for COVID-19 related endpoints as all must be identified in 2020 or later. To be counted as a COVID-19 related endpoint, the diagnosis code for each safety event of interest must be identified in combination with an inpatient diagnosis for COVID-19.</p>	

090177e1962518d5\Approved\Approved On: 29-Jan-2021 20:00 (GMT)

Appendix Table 2. Operational Definitions of Safety Events of Interest

Variable	Operational Definition	
	Defined by the presence of any of the following ICD-9-CM codes (inclusive) ¹ :	Defined by the presence of any of the following ICD-10-CM codes (inclusive) ¹ :
<i>Severe COVID-19 disease</i> ⁵⁷	N/A	<ul style="list-style-type: none"> • U07.1, COVID-19
Microangiopathy ⁵⁷	N/A	<ul style="list-style-type: none"> • M31.1, Thrombotic microangiopathy
Heart failure and cardiogenic shock ⁵⁷	N/A	<ul style="list-style-type: none"> • I50.1, Left ventricular failure, unspecified • I50.20, Unspecified systolic (congestive) heart failure • I50.21, Acute systolic (congestive) heart failure • I50.23, Acute on chronic systolic (congestive) heart failure • I50.30, Unspecified diastolic (congestive) heart failure • I50.31, Acute diastolic (congestive) heart failure

090177e1962518d5\Approved\Approved On: 29-Jan-2021 20:00 (GMT)

Appendix Table 2. Operational Definitions of Safety Events of Interest

Variable	Operational Definition	
	Defined by the presence of any of the following <u>ICD-9-CM</u> codes (inclusive) ¹ :	Defined by the presence of any of the following <u>ICD-10-CM</u> codes (inclusive) ¹ :
		<ul style="list-style-type: none"> • I50.33, Acute on chronic diastolic (congestive) heart failure • I50.40, Unspecified combined systolic (congestive) and diastolic (congestive) heart failure • I50.41, Acute combined systolic (congestive) and diastolic (congestive) heart failure • I50.43, Acute on chronic combined systolic (congestive) and diastolic (congestive) heart failure • I50.810, Right heart failure, unspecified • I50.811, Acute right heart failure

090177e1962518d5\Approved\Approved On: 29-Jan-2021 20:00 (GMT)

Appendix Table 2. Operational Definitions of Safety Events of Interest

Variable	Operational Definition	
	Defined by the presence of any of the following ICD-9-CM codes (inclusive) ¹ :	Defined by the presence of any of the following ICD-10-CM codes (inclusive) ¹ :
		<ul style="list-style-type: none"> • I50.813, Acute on chronic right heart failure • I50.814, Right heart failure due to left heart failure • I50.82, Biventricular heart failure • I50.89, Other heart failure • I50.9, Heart failure, unspecified • R57.0, Cardiogenic shock •
Stress cardiomyopathy ⁵⁷	N/A	<ul style="list-style-type: none"> • I42.7, Cardiomyopathy due to drug and external agent • I42.8, Other cardiomyopathies • I42.9, Cardiomyopathy, unspecified

090177e1962518d5\Approved\Approved On: 29-Jan-2021 20:00 (GMT)

Appendix Table 2. Operational Definitions of Safety Events of Interest

Variable	Operational Definition	
	Defined by the presence of any of the following ICD-9-CM codes (inclusive) ¹ :	Defined by the presence of any of the following ICD-10-CM codes (inclusive) ¹ :
		<ul style="list-style-type: none"> • I51.81, Takotsubo syndrome
Coronary Artery Disease (CAD) ⁵⁷	N/A	<ul style="list-style-type: none"> • I24.0, Acute coronary thrombosis not resulting in myocardial infraction • I24.8, Other forms of acute ischemic heart disease • I24.9, Acute ischemic heart disease, unspecified • I25.10, Atherosclerotic heart disease of native coronary artery without angina pectoris • I25.110, Atherosclerotic heart disease of native coronary artery with unstable angina pectoris

090177e1962518d5\Approved\Approved On: 29-Jan-2021 20:00 (GMT)

Appendix Table 2. Operational Definitions of Safety Events of Interest

Variable	Operational Definition	
	Defined by the presence of any of the following ICD-9-CM codes (inclusive) ¹ :	Defined by the presence of any of the following ICD-10-CM codes (inclusive) ¹ :
		<ul style="list-style-type: none"> • I25.111, Atherosclerotic heart disease of native coronary artery with angina pectoris with documented spasm • I25.118, Atherosclerotic heart disease of native coronary artery with other forms of angina pectoris • I25.119, Atherosclerotic heart disease of native coronary artery with unspecified angina pectoris • I25.41, Coronary artery aneurysm • I25.42, Coronary artery dissection • I25.700, Atherosclerosis of

090177e1962518d5\Approved\Approved On: 29-Jan-2021 20:00 (GMT)

Appendix Table 2. Operational Definitions of Safety Events of Interest

Variable	Operational Definition	
	Defined by the presence of any of the following ICD-9-CM codes (inclusive) ¹ :	Defined by the presence of any of the following ICD-10-CM codes (inclusive) ¹ :
		<p>coronary artery bypass graft(s), unspecified, with unstable angina pectoris</p> <ul style="list-style-type: none"> • I25.701, Atherosclerosis of coronary artery bypass graft(s), unspecified, with angina pectoris with documented spasm • I25.708, Atherosclerosis of coronary artery bypass graft(s), unspecified, with other forms of angina pectoris • I25.709, Atherosclerosis of coronary artery bypass graft(s), unspecified, with unspecified angina pectoris

090177e1962518d5\Approved\Approved On: 29-Jan-2021 20:00 (GMT)

Appendix Table 2. Operational Definitions of Safety Events of Interest

Variable	Operational Definition	
	Defined by the presence of any of the following ICD-9-CM codes (inclusive) ¹ :	Defined by the presence of any of the following ICD-10-CM codes (inclusive) ¹ :
		<ul style="list-style-type: none"> • I25.710, Atherosclerosis of autologous vein coronary artery bypass graft(s) with unstable angina pectoris • I25.711, Atherosclerosis of autologous vein coronary artery bypass graft(s) with angina pectoris with documented spasm • I25.718, Atherosclerosis of autologous vein coronary artery bypass graft(s) with other forms of angina pectoris • I25.719, Atherosclerosis of autologous vein coronary artery bypass

090177e1962518d5\Approved\Approved On: 29-Jan-2021 20:00 (GMT)

Appendix Table 2. Operational Definitions of Safety Events of Interest

Variable	Operational Definition	
	Defined by the presence of any of the following ICD-9-CM codes (inclusive) ¹ :	Defined by the presence of any of the following ICD-10-CM codes (inclusive) ¹ :
		graft(s) with unspecified angina pectoris <ul style="list-style-type: none"> • I25.720, Atherosclerosis of autologous artery coronary artery bypass graft(s) with unstable angina pectoris • I25.721, Atherosclerosis of autologous artery coronary artery bypass graft(s) with angina pectoris with documented spasm • I25.728, Atherosclerosis of autologous artery coronary artery bypass graft(s) with other forms of angina pectoris

090177e1962518d5\Approved\Approved On: 29-Jan-2021 20:00 (GMT)

Appendix Table 2. Operational Definitions of Safety Events of Interest

Variable	Operational Definition	
	Defined by the presence of any of the following <u>ICD-9-CM</u> codes (inclusive) ¹ :	Defined by the presence of any of the following <u>ICD-10-CM</u> codes (inclusive) ¹ :
		<ul style="list-style-type: none"> • I25.729, Atherosclerosis of autologous artery coronary artery bypass graft(s) with unspecified angina pectoris • I25.730, Atherosclerosis of nonautologous biological coronary artery bypass graft(s) with unstable angina pectoris • I25.731, Atherosclerosis of nonautologous biological coronary artery bypass graft(s) with angina pectoris with documented spasm • I25.738, Atherosclerosis of

090177e1962518d5\Approved\Approved On: 29-Jan-2021 20:00 (GMT)

Appendix Table 2. Operational Definitions of Safety Events of Interest

Variable	Operational Definition	
	Defined by the presence of any of the following ICD-9-CM codes (inclusive) ¹ :	Defined by the presence of any of the following ICD-10-CM codes (inclusive) ¹ :
		nonautologous biological coronary artery bypass graft(s) with other forms of angina pectoris <ul style="list-style-type: none"> • I25.739, Atherosclerosis of nonautologous biological coronary artery bypass graft(s) with unspecified angina pectoris • I25.750, Atherosclerosis of native coronary artery of transplanted heart with unstable angina • I25.751, Atherosclerosis of native coronary artery of transplanted heart with angina pectoris with documented spasm

090177e1962518d5\Approved\Approved On: 29-Jan-2021 20:00 (GMT)

Appendix Table 2. Operational Definitions of Safety Events of Interest

Variable	Operational Definition	
	Defined by the presence of any of the following ICD-9-CM codes (inclusive) ¹ :	Defined by the presence of any of the following ICD-10-CM codes (inclusive) ¹ :
		<ul style="list-style-type: none"> • I25.758, Atherosclerosis of native coronary artery of transplanted heart with other forms of angina pectoris • I25.759, Atherosclerosis of native coronary artery of transplanted heart with unspecified angina pectoris • I25.760, Atherosclerosis of bypass graft of coronary artery of transplanted heart with unstable angina • I25.761, Atherosclerosis of bypass graft of coronary artery of transplanted heart with

090177e1962518d5\Approved\Approved On: 29-Jan-2021 20:00 (GMT)

Appendix Table 2. Operational Definitions of Safety Events of Interest

Variable	Operational Definition	
	Defined by the presence of any of the following ICD-9-CM codes (inclusive) ¹ :	Defined by the presence of any of the following ICD-10-CM codes (inclusive) ¹ :
		angina pectoris with documented spasm <ul style="list-style-type: none"> • I25.768, Atherosclerosis of bypass graft of coronary artery of transplanted heart with other forms of angina pectoris • I25.769, Atherosclerosis of bypass graft of coronary artery of transplanted heart with unspecified angina pectoris • I25.790, Atherosclerosis of other coronary artery bypass graft(s) with unstable angina pectoris • I25.791, Atherosclerosis of

090177e1962518d5\Approved\Approved On: 29-Jan-2021 20:00 (GMT)

Appendix Table 2. Operational Definitions of Safety Events of Interest

Variable	Operational Definition	
	Defined by the presence of any of the following ICD-9-CM codes (inclusive) ¹ :	Defined by the presence of any of the following ICD-10-CM codes (inclusive) ¹ :
		<p>other coronary artery bypass graft(s) with angina pectoris with documented spasm</p> <ul style="list-style-type: none"> • I25.798, Atherosclerosis of other coronary artery bypass graft(s) with other forms of angina pectoris • I25.799, Atherosclerosis of other coronary artery bypass graft(s) with unspecified angina pectoris • I25.810, Atherosclerosis of coronary artery bypass graft(s) without angina pectoris • I25.811, Atherosclerosis of native coronary artery

090177e1962518d5\Approved\Approved On: 29-Jan-2021 20:00 (GMT)

Appendix Table 2. Operational Definitions of Safety Events of Interest

Variable	Operational Definition	
	Defined by the presence of any of the following ICD-9-CM codes (inclusive) ¹ :	Defined by the presence of any of the following ICD-10-CM codes (inclusive) ¹ :
		of transplanted heart without angina pectoris <ul style="list-style-type: none"> • I25.812, Atherosclerosis of bypass graft of coronary artery of transplanted heart without angina pectoris
Arrhythmia ⁵⁷	N/A	<ul style="list-style-type: none"> • I47.1, Supraventricular tachycardia • I47.2, Ventricular tachycardia • I47.9, Paroxysmal tachycardia, unspecified • I48.0, Paroxysmal atrial fibrillation • I48.3, Typical atrial flutter • I48.4, Atypical atrial flutter

090177e1962518d5\Approved\Approved On: 29-Jan-2021 20:00 (GMT)

Appendix Table 2. Operational Definitions of Safety Events of Interest

Variable	Operational Definition	
	Defined by the presence of any of the following ICD-9-CM codes (inclusive) ¹ :	Defined by the presence of any of the following ICD-10-CM codes (inclusive) ¹ :
		<ul style="list-style-type: none"> • I48.91, Unspecified atrial fibrillation • I48.92, Unspecified atrial flutter
Deep vein thrombosis (DVT) ⁵⁷	N/A	<ul style="list-style-type: none"> • I82.401, Acute embolism and thrombosis of unspecified deep veins of right lower extremity • I82.402, Acute embolism and thrombosis of unspecified deep veins of left lower extremity • I82.403, Acute embolism and thrombosis of unspecified deep veins of lower extremity, bilateral • I82.409, Acute embolism and

090177e1962518d5\Approved\Approved On: 29-Jan-2021 20:00 (GMT)

Appendix Table 2. Operational Definitions of Safety Events of Interest

Variable	Operational Definition	
	Defined by the presence of any of the following <u>ICD-9-CM</u> codes (inclusive) ¹ :	Defined by the presence of any of the following <u>ICD-10-CM</u> codes (inclusive) ¹ :
		thrombosis of unspecified deep veins of unspecified lower extremity <ul style="list-style-type: none"> • I82.411, Acute embolism and thrombosis of right femoral vein • I82.412, Acute embolism and thrombosis of left femoral vein • I82.413, Acute embolism and thrombosis of femoral vein, bilateral • I82.419, Acute embolism and thrombosis of unspecified femoral vein • I82.421, Acute embolism and

090177e1962518d5\Approved\Approved On: 29-Jan-2021 20:00 (GMT)

Appendix Table 2. Operational Definitions of Safety Events of Interest

Variable	Operational Definition	
	Defined by the presence of any of the following <u>ICD-9-CM</u> codes (inclusive) ¹ :	Defined by the presence of any of the following <u>ICD-10-CM</u> codes (inclusive) ¹ :
		thrombosis of right iliac vein <ul style="list-style-type: none"> • I82.422, Acute embolism and thrombosis of left iliac vein • I82.423, Acute embolism and thrombosis of iliac vein, bilateral • I82.429, Acute embolism and thrombosis of unspecified iliac vein • I82.431, Acute embolism and thrombosis of right popliteal vein • I82.432, Acute embolism and thrombosis of left popliteal vein • I82.433, Acute embolism and

090177e1962518d5\Approved\Approved On: 29-Jan-2021 20:00 (GMT)

Appendix Table 2. Operational Definitions of Safety Events of Interest

Variable	Operational Definition	
	Defined by the presence of any of the following <u>ICD-9-CM</u> codes (inclusive) ¹ :	Defined by the presence of any of the following <u>ICD-10-CM</u> codes (inclusive) ¹ :
		thrombosis of popliteal vein, bilateral <ul style="list-style-type: none"> • I82.439, Acute embolism and thrombosis of unspecified popliteal vein • I82.441, Acute embolism and thrombosis of right tibial vein • I82.442, Acute embolism and thrombosis of left tibial vein • I82.443, Acute embolism and thrombosis of tibial vein, bilateral • I82.449, Acute embolism and thrombosis of unspecified tibial vein

090177e1962518d5\Approved\Approved On: 29-Jan-2021 20:00 (GMT)

Appendix Table 2. Operational Definitions of Safety Events of Interest

Variable	Operational Definition	
	Defined by the presence of any of the following ICD-9-CM codes (inclusive) ¹ :	Defined by the presence of any of the following ICD-10-CM codes (inclusive) ¹ :
		<ul style="list-style-type: none"> • I82.451, Acute embolism and thrombosis of right peroneal vein • I82.452, Acute embolism and thrombosis of left peroneal vein • I82.453, Acute embolism and thrombosis of peroneal vein, bilateral • I82.459, Acute embolism and thrombosis of unspecified peroneal vein • I82.461, Acute embolism and thrombosis of right calf muscular vein • I82.462, Acute embolism and

090177e1962518d5\Approved\Approved On: 29-Jan-2021 20:00 (GMT)

Appendix Table 2. Operational Definitions of Safety Events of Interest

Variable	Operational Definition	
	Defined by the presence of any of the following <u>ICD-9-CM</u> codes (inclusive) ¹ :	Defined by the presence of any of the following <u>ICD-10-CM</u> codes (inclusive) ¹ :
		thrombosis of left calf muscular vein <ul style="list-style-type: none"> • I82.463, Acute embolism and thrombosis of calf muscular vein, bilateral • I82.469, Acute embolism and thrombosis of unspecified calf muscular vein • I82.491, Acute embolism and thrombosis of other specified deep vein of right lower extremity • I82.492, Acute embolism and thrombosis of other specified deep vein of left lower extremity • I82.493, Acute embolism and

090177e1962518d5\Approved\Approved On: 29-Jan-2021 20:00 (GMT)

Appendix Table 2. Operational Definitions of Safety Events of Interest

Variable	Operational Definition	
	Defined by the presence of any of the following ICD-9-CM codes (inclusive) ¹ :	Defined by the presence of any of the following ICD-10-CM codes (inclusive) ¹ :
		thrombosis of other specified deep vein of lower extremity, bilateral <ul style="list-style-type: none"> • I82.499, Acute embolism and thrombosis of other specified deep vein of unspecified lower extremity • I82.4Y1, Acute embolism and thrombosis of unspecified deep veins of right proximal lower extremity • I82.4Y2, Acute embolism and thrombosis of unspecified deep veins of left proximal lower extremity • I82.4Y3, Acute embolism and

090177e1962518d5\Approved\Approved On: 29-Jan-2021 20:00 (GMT)

Appendix Table 2. Operational Definitions of Safety Events of Interest

Variable	Operational Definition	
	Defined by the presence of any of the following ICD-9-CM codes (inclusive) ¹ :	Defined by the presence of any of the following ICD-10-CM codes (inclusive) ¹ :
		<p>thrombosis of unspecified deep veins of proximal lower extremity, bilateral</p> <ul style="list-style-type: none"> • I82.4Y9, Acute embolism and thrombosis of unspecified deep veins of unspecified proximal lower extremity • I82.4Z1, Acute embolism and thrombosis of unspecified deep veins of right distal lower extremity • I82.4Z2, Acute embolism and thrombosis of unspecified deep veins of left distal lower extremity

090177e1962518d5\Approved\Approved On: 29-Jan-2021 20:00 (GMT)

Appendix Table 2. Operational Definitions of Safety Events of Interest

Variable	Operational Definition	
	Defined by the presence of any of the following <u>ICD-9-CM</u> codes (inclusive) ¹ :	Defined by the presence of any of the following <u>ICD-10-CM</u> codes (inclusive) ¹ :
		<ul style="list-style-type: none"> • I82.4Z3, Acute embolism and thrombosis of unspecified deep veins of distal lower extremity, bilateral • I82.4Z9, Acute embolism and thrombosis of unspecified deep veins of unspecified distal lower extremity • I82.601, Acute embolism and thrombosis of unspecified veins of right upper extremity • I82.602, Acute embolism and thrombosis of unspecified veins of left upper extremity • I82.603, Acute embolism and

090177e1962518d5\Approved\Approved On: 29-Jan-2021 20:00 (GMT)

Appendix Table 2. Operational Definitions of Safety Events of Interest

Variable	Operational Definition	
	Defined by the presence of any of the following <u>ICD-9-CM</u> codes (inclusive) ¹ :	Defined by the presence of any of the following <u>ICD-10-CM</u> codes (inclusive) ¹ :
		thrombosis of unspecified veins of upper extremity, bilateral <ul style="list-style-type: none"> • I82.609, Acute embolism and thrombosis of unspecified veins of unspecified upper extremity • I82.611, Acute embolism and thrombosis of superficial veins of right upper extremity • I82.612, Acute embolism and thrombosis of superficial veins of left upper extremity • I82.613, Acute embolism and thrombosis of superficial veins of

090177e1962518d5\Approved\Approved On: 29-Jan-2021 20:00 (GMT)

Appendix Table 2. Operational Definitions of Safety Events of Interest

Variable	Operational Definition	
	Defined by the presence of any of the following <u>ICD-9-CM</u> codes (inclusive) ¹ :	Defined by the presence of any of the following <u>ICD-10-CM</u> codes (inclusive) ¹ :
		upper extremity, bilateral <ul style="list-style-type: none"> • I82.619, Acute embolism and thrombosis of superficial veins of unspecified upper extremity • I82.621, Acute embolism and thrombosis of deep veins of right upper extremity • I82.622, Acute embolism and thrombosis of deep veins of left upper extremity • I82.623, Acute embolism and thrombosis of deep veins of upper extremity, bilateral

090177e1962518d5\Approved\Approved On: 29-Jan-2021 20:00 (GMT)

Appendix Table 2. Operational Definitions of Safety Events of Interest

Variable	Operational Definition	
	Defined by the presence of any of the following <u>ICD-9-CM</u> codes (inclusive) ¹ :	Defined by the presence of any of the following <u>ICD-10-CM</u> codes (inclusive) ¹ :
		<ul style="list-style-type: none"> • I82.629, Acute embolism and thrombosis of deep veins of unspecified upper extremity • I82.811, Embolism and thrombosis of superficial veins of right lower extremity • I82.812, Embolism and thrombosis of superficial veins of left lower extremity • I82.813, Embolism and thrombosis of superficial veins of lower extremities, bilateral • I82.819, Embolism and thrombosis of superficial veins of unspecified lower extremity

090177e1962518d5\Approved\Approved On: 29-Jan-2021 20:00 (GMT)

Appendix Table 2. Operational Definitions of Safety Events of Interest

Variable	Operational Definition	
	Defined by the presence of any of the following ICD-9-CM codes (inclusive) ¹ :	Defined by the presence of any of the following ICD-10-CM codes (inclusive) ¹ :
		<ul style="list-style-type: none"> • I82.890, Acute embolism and thrombosis of other specified veins • I82.90, Acute embolism and thrombosis of unspecified vein
Pulmonary embolus ⁵⁷	N/A	<ul style="list-style-type: none"> • I26.02, Saddle embolus of pulmonary artery with acute cor pulmonale • I26.09, Other pulmonary embolism with acute cor pulmonale • I26.90, Septic pulmonary embolism without acute cor pulmonale • I26.92, Saddle embolus of pulmonary

090177e1962518d5\Approved\Approved On: 29-Jan-2021 20:00 (GMT)

Appendix Table 2. Operational Definitions of Safety Events of Interest

Variable	Operational Definition	
	Defined by the presence of any of the following ICD-9-CM codes (inclusive) ¹ :	Defined by the presence of any of the following ICD-10-CM codes (inclusive) ¹ :
		artery without acute cor pulmonale <ul style="list-style-type: none"> • I26.93, Single subsegmental pulmonary embolism without acute cor pulmonale • I26.94, Multiple subsegmental pulmonary emboli without acute cor pulmonale • I26.99, Other pulmonary embolism without acute cor pulmonale
<i>Cerebrovascular hemorrhagic stroke</i> ^{9,25}	N/A	<ul style="list-style-type: none"> • I60.9, Nontraumatic subarachnoid hemorrhage, unspecified • I61.9, Nontraumatic intracerebral

090177e1962518d5\Approved\Approved On: 29-Jan-2021 20:00 (GMT)

Appendix Table 2. Operational Definitions of Safety Events of Interest

Variable	Operational Definition	
	Defined by the presence of any of the following ICD-9-CM codes (inclusive) ¹ :	Defined by the presence of any of the following ICD-10-CM codes (inclusive) ¹ :
		<ul style="list-style-type: none"> hemorrhage, unspecified • I62.1, Nontraumatic extradural hemorrhage • I62.00, Nontraumatic subdural hemorrhage, unspecified • I62.9, Nontraumatic intracranial hemorrhage, unspecified
<i>Cerebrovascular non-hemorrhagic stroke</i> ^{9,25}	N/A	<ul style="list-style-type: none"> • I63, Cerebral infarction
Limb ischemia ⁵⁷	N/A	<ul style="list-style-type: none"> • I99.8, Other disorder of circulatory system
Hemorrhagic disease (excluding those limited as separate outcomes) ⁵⁷	N/A	<ul style="list-style-type: none"> • D69.8, Other specified hemorrhagic conditions • D69.9, Hemorrhagic condition, unspecified

090177e1962518d5\Approved\Approved On: 29-Jan-2021 20:00 (GMT)

Appendix Table 2. Operational Definitions of Safety Events of Interest

Variable	Operational Definition	
	Defined by the presence of any of the following ICD-9-CM codes (inclusive) ¹ :	Defined by the presence of any of the following ICD-10-CM codes (inclusive) ¹ :
		<ul style="list-style-type: none"> • A988, Other specified viral hemorrhagic fevers • A99, Unspecified viral hemorrhagic fever • A985, Hemorrhagic fever with renal syndrome • G0439, Other acute necrotizing hemorrhagic encephalopathy
Acute kidney injury ⁶⁰	N/A	<ul style="list-style-type: none"> • N17.9, Acute kidney failure, unspecified <p>Laboratory result:⁶¹</p> <ul style="list-style-type: none"> • Grade 3: <ul style="list-style-type: none"> ○ Estimated glomerular filtration rate (eGFR) or creatinine clearance

090177e1962518d5\Approved\Approved On: 29-Jan-2021 20:00 (GMT)

Appendix Table 2. Operational Definitions of Safety Events of Interest

Variable	Operational Definition	
	Defined by the presence of any of the following ICD-9-CM codes (inclusive) ¹ :	Defined by the presence of any of the following ICD-10-CM codes (inclusive) ¹ :
		<p>(CrCl) 29 -15 ml/min/1.73 m²</p> <ul style="list-style-type: none"> • Grade 4: <ul style="list-style-type: none"> ○ eGFR or CrCl <15 ml/min/1.73 m²; dialysis or renal transplant indicated • Grade 5: <ul style="list-style-type: none"> ○ Death
Liver injury ⁶²	N/A	<ul style="list-style-type: none"> • K76.8, Other specified diseases of liver • K76.9, Liver disease, unspecified • R17, Unspecified jaundice, excludes neonatal • R16.0, Hepatomegaly, not elsewhere classified

090177e1962518d5\Approved\Approved On: 29-Jan-2021 20:00 (GMT)

Appendix Table 2. Operational Definitions of Safety Events of Interest

Variable	Operational Definition	
	Defined by the presence of any of the following ICD-9-CM codes (inclusive) ¹ :	Defined by the presence of any of the following ICD-10-CM codes (inclusive) ¹ :
		<ul style="list-style-type: none"> • R16.2, Hepatomegaly with splenomegaly, not elsewhere classified • R74.0, Nonspecific elevation of transaminase and lactic acid dehydrogenase • K71.0, Toxic liver disease with cholestasis • K71.1, Toxic liver disease with hepatic necrosis • K71.10, Toxic liver disease with hepatic necrosis, without coma • K71.11, Toxic liver disease with hepatic necrosis, with coma • K71.2, Toxic liver disease with acute hepatitis

090177e1962518d5\Approved\Approved On: 29-Jan-2021 20:00 (GMT)

Appendix Table 2. Operational Definitions of Safety Events of Interest

Variable	Operational Definition	
	Defined by the presence of any of the following ICD-9-CM codes (inclusive) ¹ :	Defined by the presence of any of the following ICD-10-CM codes (inclusive) ¹ :
		<ul style="list-style-type: none"> • K71.6, Toxic liver disease with hepatitis, not elsewhere classified • K71.9, Toxic liver disease, unspecified • K72.9, Hepatic failure, unspecified • K72.90, Hepatic failure, unspecified without coma • K72.91, Hepatic failure, unspecified with coma • K75.9, Inflammatory liver disease • K76.2, Central hemorrhagic necrosis of liver <p>Laboratory result:⁶¹</p> <ul style="list-style-type: none"> • Grade 3:

090177e1962518d5\Approved\Approved On: 29-Jan-2021 20:00 (GMT)

Appendix Table 2. Operational Definitions of Safety Events of Interest

Variable	Operational Definition	
	Defined by the presence of any of the following ICD-9-CM codes (inclusive) ¹ :	Defined by the presence of any of the following ICD-10-CM codes (inclusive) ¹ :
		<ul style="list-style-type: none"> ○ Aspartate transaminase (AST) or alanine transaminase (ALT): >5.0 - 20.0x upper LN (ULN) if baseline was normal; >5.0-20.0x baseline if baseline was abnormal ○ Blood bilirubin: >3.0-10.0x ULN if baseline was normal; >3.0-10.0x baseline if baseline was abnormal ● Grade 4: <ul style="list-style-type: none"> ○ AST or ALT: >20.0x ULN if

090177e1962518d5\Approved\Approved On: 29-Jan-2021 20:00 (GMT)

Appendix Table 2. Operational Definitions of Safety Events of Interest

Variable	Operational Definition	
	Defined by the presence of any of the following ICD-9-CM codes (inclusive) ¹ :	Defined by the presence of any of the following ICD-10-CM codes (inclusive) ¹ :
		<p>baseline was normal; >20.0x if baseline was abnormal</p> <ul style="list-style-type: none"> ○ Blood bilirubin: >10.0x ULN if baseline was normal; >10.0x baseline if baseline was abnormal • Grade 5: <ul style="list-style-type: none"> ○ Death <p>The presence of any of the following codes will not result in the safety events of interest being considered an event:</p> <ul style="list-style-type: none"> • B15-B19, Viral hepatitis

090177e1962518d5\Approved\Approved On: 29-Jan-2021 20:00 (GMT)

Appendix Table 2. Operational Definitions of Safety Events of Interest

Variable	Operational Definition	
	Defined by the presence of any of the following ICD-9-CM codes (inclusive) ¹ :	Defined by the presence of any of the following ICD-10-CM codes (inclusive) ¹ :
		<ul style="list-style-type: none"> • C22, Malignant neoplasm of liver and intrahepatic bile ducts • K72.0, Acute and subacute hepatic failure paired with any of the following: <ul style="list-style-type: none"> ○ 50.811, Acute right heart failure ○ I95, Hypotension • K77, Liver disorders in diseases classified elsewhere
Chilblain-like lesions ⁵⁷	N/A	<ul style="list-style-type: none"> • T69.1XXA, Chilblains, initial encounter
Single organ cutaneous vasculitis ⁵⁷	N/A	<ul style="list-style-type: none"> • L95.8, Other vasculitis limited to the skin

090177e1962518d5\Approved\Approved On: 29-Jan-2021 20:00 (GMT)

Appendix Table 2. Operational Definitions of Safety Events of Interest

Variable	Operational Definition	
	Defined by the presence of any of the following ICD-9-CM codes (inclusive) ¹ :	Defined by the presence of any of the following ICD-10-CM codes (inclusive) ¹ :
		<ul style="list-style-type: none"> • L95.9, Vasculitis limited to the skin, unspecified
Erythema multiforme ⁵⁷	N/A	<ul style="list-style-type: none"> • L51.0, Nonbullous erythema multiforme • L51.8, Other erythema multiforme • L51.9, Erythema multiforme, unspecified • L51.1, Stevens-Johnson syndrome • L51.2, Toxic epidermal necrolysis [Lyell] • L51.3, Stevens-Johnson synd-tox epdrml necrolysis overlap syndrome
Other		

090177e1962518d5\Approved\Approved On: 29-Jan-2021 20:00 (GMT)

Appendix Table 2. Operational Definitions of Safety Events of Interest

Variable	Operational Definition	
	Defined by the presence of any of the following ICD-9-CM codes (inclusive) ¹ :	Defined by the presence of any of the following ICD-10-CM codes (inclusive) ¹ :
Pregnancy outcomes ³⁶	<ul style="list-style-type: none"> • 641.2, Premature separation of placenta, unspecified as to episode of care or not applicable • 641.21, Premature separation of placenta, delivered, with or without mention of antepartum condition • 641.23, Premature separation of placenta, antepartum condition or complication • 642.4, Mild or unspecified pre-eclampsia, unspecified as to episode of care or not applicable • 642.41, Mild or unspecified pre-eclampsia, delivered, with or without mention of antepartum condition • 642.42, Mild or unspecified pre-eclampsia, delivered, with mention of postpartum complication • 642.43, Mild or unspecified pre-eclampsia, antepartum condition or complication • 642.44, Mild or unspecified pre-eclampsia, postpartum condition or complication • 642.5, Severe pre-eclampsia, unspecified as to episode of care or not applicable 	<ul style="list-style-type: none"> • O14.00, Mild to moderate pre-eclampsia, unspecified trimester • O14.02, Mild to moderate pre-eclampsia, second trimester • O14.03, Mild to moderate pre-eclampsia, third trimester • O14.04, Mild to moderate pre-eclampsia, complicating childbirth • O14.05, Mild to moderate pre-eclampsia, complicating the puerperium • O14.10, Severe pre-eclampsia, unspecified trimester

090177e1962518d5\Approved\Approved On: 29-Jan-2021 20:00 (GMT)

Appendix Table 2. Operational Definitions of Safety Events of Interest

Variable	Operational Definition	
	Defined by the presence of any of the following ICD-9-CM codes (inclusive) ¹ :	Defined by the presence of any of the following ICD-10-CM codes (inclusive) ¹ :
	<ul style="list-style-type: none"> • 642.51, Severe pre-eclampsia, delivered, with or without mention of antepartum condition • 642.51, Severe pre-eclampsia, delivered, with or without mention of antepartum condition • 642.52, Severe pre-eclampsia, delivered, with mention of postpartum complication • 642.53, Severe pre-eclampsia, antepartum condition or complication • 642.54, Severe pre-eclampsia, postpartum condition or complication • 642.54, Severe pre-eclampsia, postpartum condition or complication • condition or complication • 642.61, Eclampsia, delivered, with or without mention of antepartum condition • without mention of antepartum condition • 642.62, Eclampsia, delivered, with mention of postpartum complication • 642.63, Eclampsia, antepartum condition or complication • 642.64, Eclampsia, postpartum condition or complication 	<ul style="list-style-type: none"> • O14.12, Severe pre-eclampsia, second trimester • O14.13, Severe pre-eclampsia, third trimester • O14.14, Severe pre-eclampsia complicating childbirth • O14.15, Severe pre-eclampsia, complicating the puerperium • O14.20, HELLP syndrome (HELLP), unspecified trimester • O14.22, HELLP syndrome (HELLP), second trimester • O14.23, HELLP syndrome (HELLP), third trimester

090177e1962518d5\Approved\Approved On: 29-Jan-2021 20:00 (GMT)

Appendix Table 2. Operational Definitions of Safety Events of Interest

Variable	Operational Definition	
	Defined by the presence of any of the following ICD-9-CM codes (inclusive) ¹ :	Defined by the presence of any of the following ICD-10-CM codes (inclusive) ¹ :
	<ul style="list-style-type: none"> • 642.7, Pre-eclampsia or eclampsia superimposed on pre-existing hypertension, unspecified as to episode of care or not applicable • 642.71, Pre-eclampsia or eclampsia superimposed on pre-existing hypertension, delivered, with or without mention of antepartum condition • 642.72, Pre-eclampsia or eclampsia superimposed on pre-existing hypertension, delivered, with mention of postpartum complication • 642.73, Pre-eclampsia or eclampsia superimposed on pre-existing hypertension, antepartum condition or complication • 642.74, Pre-eclampsia or eclampsia superimposed on pre-existing hypertension, postpartum condition or complication • 649.81, Onset (spontaneous) of labor after 37 completed weeks of gestation but before 39 completed weeks gestation, with delivery by (planned) cesarean section, delivered, with or without mention of antepartum condition 	<ul style="list-style-type: none"> • O14.24, HELLP syndrome, complicating childbirth • O14.25, HELLP syndrome, complicating the puerperium • O14.90, Unspecified pre-eclampsia, unspecified trimester • O14.92, Unspecified pre-eclampsia, second trimester • O14.93, Unspecified pre-eclampsia, third trimester • O14.94, Unspecified pre-eclampsia, complicating childbirth • O14.95, Unspecified pre-eclampsia, complicating the puerperium

090177e1962518d5\Approved\Approved On: 29-Jan-2021 20:00 (GMT)

Appendix Table 2. Operational Definitions of Safety Events of Interest

Variable	Operational Definition	
	Defined by the presence of any of the following ICD-9-CM codes (inclusive) ¹ :	Defined by the presence of any of the following ICD-10-CM codes (inclusive) ¹ :
	<ul style="list-style-type: none"> • 649.82, Onset (spontaneous) of labor after 37 completed weeks of gestation but before 39 completed weeks gestation, with delivery by (planned) cesarean section, delivered, with mention of postpartum complication • 666.02, Third-stage postpartum hemorrhage, delivered, with mention of postpartum complication • 666.04, Third-stage postpartum hemorrhage, postpartum condition or complication • 666.1, Other immediate postpartum hemorrhage, unspecified as to episode of care or not applicable • 666.12, Other immediate postpartum hemorrhage, delivered, with mention of postpartum complication • 666.14, Other immediate postpartum hemorrhage, postpartum condition or complication • 666.2, Delayed and secondary postpartum hemorrhage, unspecified as to episode of care or not applicable 	<ul style="list-style-type: none"> • O15.02, Eclampsia complicating pregnancy, second trimester • O15.03, Eclampsia complicating pregnancy, third trimester • O15.1, Eclampsia complicating labor • O15.2, Eclampsia complicating the puerperium • O72.0, Third-stage hemorrhage • O42.00, Premature rupture of membranes, onset of labor within 24 hours of rupture, unspecified weeks of gestation • O42.011, Preterm premature rupture of

090177e1962518d5\Approved\Approved On: 29-Jan-2021 20:00 (GMT)

Appendix Table 2. Operational Definitions of Safety Events of Interest

Variable	Operational Definition	
	Defined by the presence of any of the following ICD-9-CM codes (inclusive) ¹ :	Defined by the presence of any of the following ICD-10-CM codes (inclusive) ¹ :
	<ul style="list-style-type: none"> • 666.22, Delayed and secondary postpartum hemorrhage, delivered, with mention of postpartum complication • 666.24, Delayed and secondary postpartum hemorrhage, postpartum condition or complication • 666.32, Postpartum coagulation defects, delivered, with mention of postpartum complication • 658.1, Premature rupture of membranes, unspecified as to episode of care or not applicable • 658.11, Premature rupture of membranes, delivered, with or without mention of antepartum condition • 658.13, Premature rupture of membranes, antepartum condition or complication • 761.1, Premature rupture of membranes affecting fetus or newborn • 762.1, Other forms of placental separation and hemorrhage affecting fetus or newborn • 762.7, Chorioamnionitis affecting fetus or newborn 	<p>membranes, onset of labor within 24 hours of rupture, first trimester</p> <ul style="list-style-type: none"> • O42.012, Preterm premature rupture of membranes, onset of labor within 24 hours of rupture, second trimester • O42.013, Preterm premature rupture of membranes, onset of labor within 24 hours of rupture, third trimester • 43.233, Placenta percreta, third trimester • O43.232, Placenta percreta, second trimester • O43.231, Placenta percreta, first trimester

090177e1962518d5\Approved\Approved On: 29-Jan-2021 20:00 (GMT)

Appendix Table 2. Operational Definitions of Safety Events of Interest

Variable	Operational Definition	
	Defined by the presence of any of the following ICD-9-CM codes (inclusive) ¹ :	Defined by the presence of any of the following ICD-10-CM codes (inclusive) ¹ :
	<ul style="list-style-type: none"> • 763.4, Cesarean delivery affecting fetus or newborn <p>CPT codes:</p> <ul style="list-style-type: none"> • 59510, 59514, 59515, Under cesarean delivery procedures <p>ICD-9-PCS</p> <ul style="list-style-type: none"> • 74.3, Removal of extratubal ectopic pregnancy • 74.91, Hysterotomy to terminate pregnancy 	<ul style="list-style-type: none"> • O43.223, Placenta increta, third trimester • O43.222, Placenta increta, second trimester • O43.221, Placenta increta, first trimester • O43.213, Placenta accreta, third trimester • O43.212, Placenta accreta, second trimester • O43.211, Placenta accreta, first trimester • O72.1, Other immediate postpartum hemorrhage • O72.2, Delayed and secondary postpartum hemorrhage • O72.3, Postpartum coagulation defects

090177e1962518d5\Approved\Approved On: 29-Jan-2021 20:00 (GMT)

Appendix Table 2. Operational Definitions of Safety Events of Interest

Variable	Operational Definition	
	Defined by the presence of any of the following ICD-9-CM codes (inclusive) ¹ :	Defined by the presence of any of the following ICD-10-CM codes (inclusive) ¹ :
		<ul style="list-style-type: none"> • P01.1, Newborn affected by premature rupture of membranes • P02.7, Newborn affected by chorioamnionitis • O45.8X9, Other premature separation of placenta, unspecified trimester • O45.8X1, Other premature separation of placenta, first trimester • O45.8X2, Other premature separation of placenta, second trimester • O45.8X3, Other premature separation of placenta, third trimester

090177e1962518d5\Approved\Approved On: 29-Jan-2021 20:00 (GMT)

Appendix Table 2. Operational Definitions of Safety Events of Interest

Variable	Operational Definition	
	Defined by the presence of any of the following ICD-9-CM codes (inclusive) ¹ :	Defined by the presence of any of the following ICD-10-CM codes (inclusive) ¹ :
		<ul style="list-style-type: none"> • O45.91, Premature separation of placenta, unspecified, first trimester • O45.92, Premature separation of placenta, unspecified, second trimester • O45.93, Premature separation of placenta, unspecified, third trimester • O75.82, Onset (spontaneous) of labor after 37 completed weeks of gestation but before 39 completed weeks gestation, with delivery by (planned) cesarean section
<i>Death</i>	<ul style="list-style-type: none"> • Defined by the “deathcode” variable. ‘Y’ indicates the person is dead 	

090177e1962518d5\Approved\Approved On: 29-Jan-2021 20:00 (GMT)

Appendix Table 2. Operational Definitions of Safety Events of Interest

Variable	Operational Definition	
	Defined by the presence of any of the following ICD-9-CM codes (inclusive) ¹ :	Defined by the presence of any of the following ICD-10-CM codes (inclusive) ¹ :
<i>Narcolepsy/cataplexy</i> ⁵⁷	<ul style="list-style-type: none"> • 347, Narcolepsy, without cataplexy • 347.01, Narcolepsy, with cataplexy • 347.1, Narcolepsy in conditions classified elsewhere, without cataplexy • 347.11, Narcolepsy in conditions classified elsewhere, with cataplexy 	<ul style="list-style-type: none"> • G47.411, Narcolepsy with cataplexy • G47.419, Narcolepsy without cataplexy • G47.421, Narcolepsy in conditions classified elsewhere with cataplexy • G47.429, Narcolepsy in conditions classified elsewhere without cataplexy
Non-anaphylactic allergic reactions ^{9,25}	<ul style="list-style-type: none"> • 708, Allergic urticaria • 708.1, Idiopathic urticaria • 708.9, Urticaria, unspecified • 995.1, Angioneurotic edema, not elsewhere classified • 995.3, Allergy, unspecified, not elsewhere classified 	<ul style="list-style-type: none"> • L50.0, Allergic urticaria • L50.1, Idiopathic urticaria • L50.9, Urticaria, unspecified • T78.3XXA, Angioneurotic edema, initial encounter

090177e1962518d5\Approved\Approved On: 29-Jan-2021 20:00 (GMT)

Appendix Table 2. Operational Definitions of Safety Events of Interest

Variable	Operational Definition	
	Defined by the presence of any of the following ICD-9-CM codes (inclusive) ¹ :	Defined by the presence of any of the following ICD-10-CM codes (inclusive) ¹ :
		<ul style="list-style-type: none"> • T78.40XA, Allergy, unspecified, initial encounter
Appendicitis ⁵⁷	<ul style="list-style-type: none"> • 540.9, Acute appendicitis without mention of peritonitis • 542, Other appendicitis • 541, Appendicitis, unqualified 	<ul style="list-style-type: none"> • K35.20, Acute appendicitis with generalized peritonitis, without abscess • K35.21, Acute appendicitis with generalized peritonitis, with abscess • K35.30, Acute appendicitis with localized peritonitis, without perforation or gangrene • K35.31, Acute appendicitis with localized peritonitis and gangrene, without perforation • K35.32, Acute appendicitis with

090177e1962518d5\Approved\Approved On: 29-Jan-2021 20:00 (GMT)

Appendix Table 2. Operational Definitions of Safety Events of Interest

Variable	Operational Definition	
	Defined by the presence of any of the following ICD-9-CM codes (inclusive) ¹ :	Defined by the presence of any of the following ICD-10-CM codes (inclusive) ¹ :
		perforation and localized peritonitis, without abscess <ul style="list-style-type: none"> • K35.33, Acute appendicitis with perforation and localized peritonitis, with abscess • K35.80, Unspecified acute appendicitis • K35.890, Other acute appendicitis without perforation or gangrene • K35.891, Other acute appendicitis without perforation, with gangrene • K36, Other appendicitis • K37, Unspecified appendicitis

090177e1962518d5\Approved\Approved On: 29-Jan-2021 20:00 (GMT)

Document Approval Record

Document Name: C4591011 DoD protocol_1.29.2021_Final_Approved

Document Title: C4591011 DoD protocol_1.29.2021_Final_Approved

Signed By:	Date(GMT)	Signing Capacity
Campbell, Ulka	29-Jan-2021 19:27:06	Final Approval
De Bernardi, Barbara	29-Jan-2021 20:00:29	EUQPPV Approval